

SPECIFICATIONS

Current rating: 3A AC/DC
 Voltage rating: 250V AC/DC
 Contact resistance: 20mΩ max.
 Withstand voltage: 1000V AC/min
 Insulation resistance: 500MΩ/min.
 Temperature range: -25°C~+85°C

Material:

Part No: 2~16
 Post: Brass. Tin/plated
 Base: LCP UL94V-0

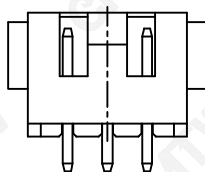
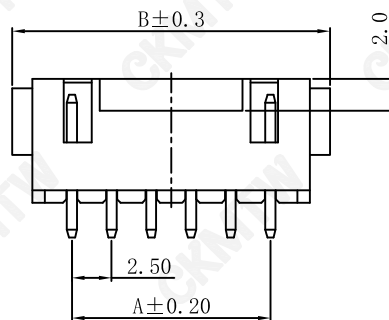
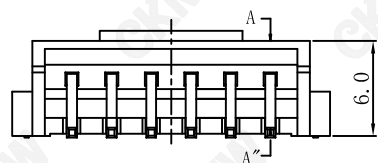
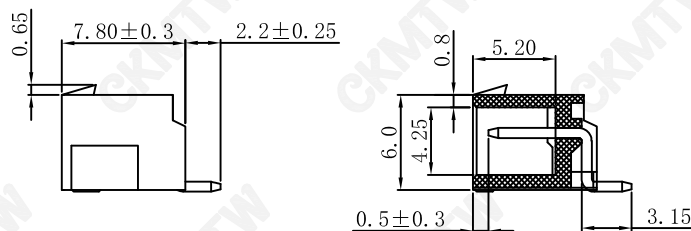

3P

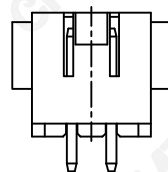

2P

Poles	PART NO.	Dimension mm	
		A	B
2	W-2502M02P-B200	2.50	10.00
3	W-2502M03P-B200	5.00	12.50
4	W-2502M04P-B200	7.50	15.00
5	W-2502M05P-B200	10.00	17.50
6	W-2502M06P-B200	12.50	20.00
7	W-2502M07P-B200	15.00	22.50
8	W-2502M08P-B200	17.50	25.00
9	W-2502M09P-B200	20.00	27.50
10	W-2502M10P-B200	22.50	30.00
11	W-2502M11P-B200	25.00	32.50
12	W-2502M12P-B200	27.50	35.00
13	W-2502M13P-B200	30.00	37.50
14	W-2502M14P-B200	32.50	40.00
15	W-2502M15P-B200	35.00	42.50
16	W-2502M16P-B200	37.50	45.00

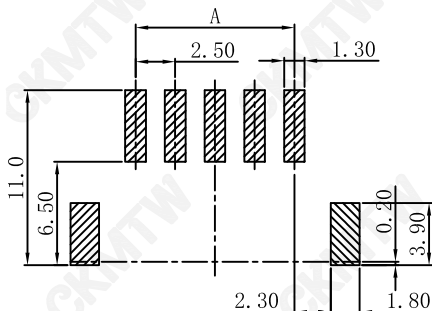

安装 P. B. C 板
 Recommended P. B. C. LoYout

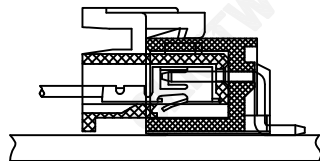

TOLERANCE TABLE

.0	±0.30
.00	±0.15
.000	±0.05

APPROVED:	DATE:	Ckmtw 深圳市灿科盟实业有限公司 CHANKLEMENT INDUSTRY CO., LTD				
CHECKED:	DATE:	TITLE: 2501SMT-XP 卧贴 带扣				
DRAWN: LYF	DATE: 2024-07-11	PROD. NO.	W-2502MXXP-B200			
		UNIT	mm	SCALE	free	⊕ ⊖
		FILE NO.	Ckmtw-2501-B0006	REV.	A	JLX1