

Features

- excellent power handling
- small size
- temperature stable
- LTCC construction, and has good moisture resistance, corrosion resistance, high reliability.

Applications

- Harmonic rejection
- Transmitters / Receivers

HT-BFCN-2850+

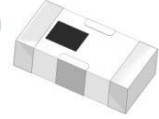

50Ω 2750 to 2950 MHz

Electrical Specifications at 25°C						
Parameter		Frequency(MHz)	Min.	Typ.	Max.	Unit
Pass Band	Center Frequency	2750-2950	-	2850.2	-	MHz
	Insertion Loss	2750-2950	-	0	3.0	B
Stop Band, Lower	VSWR	2750-2950	-	1.6	2.5	:1
	Insertion Loss	2100	21	28	-	dB
Stop Band, Upper	VSWR	2100	-	23	-	:1
	Insertion Loss	5600-8000	20	25	-	dB
Stop Band, Upper	VSWR	5600-8000	-	16	-	:1

Maximum Ratings	
Operating Temperature	-55°C to 100°C
Storage Temperature	-55°C to 100°C
RF Power Input*	2.5W .at 25°C

*Passband rating, derate linearly to 0.7W at 100°C ambient
 †Maximum ratings may vary if any stress limits are exceeded.

Pin Connections	
RF IN	1
RF OUT	3
GROUND	2,4

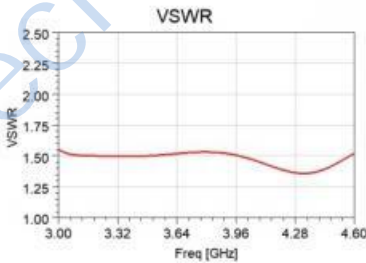
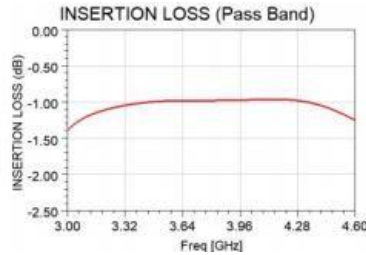

Demo Board P/N: T-39 Suggested PCB Layout (PL-137)

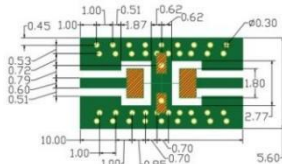

- NOTES: 1. COPLANAR WAVEGUIDE PARAMETERS ARE SHOWN FOR ROGERS RO4350 WITH THICKNESS .508" ± .0015". COPPER: 1/2 OZ. EACH SIDE. FOR OTHER MATERIALS TRACE WIDTH & GAP MAY NEED TO BE MODIFIED.
2. BOTTOM SIDE OF THE PCB IS CONTINUOUS GROUND PLANE.
 DENOTES PCB COPPER LAYOUT WITH SMOBC (SOLDER MASK OVER BARE COPPER)
 DENOTES COPPER LAND PATTERN FREE OF SOLDER MASK

Functional Schematic

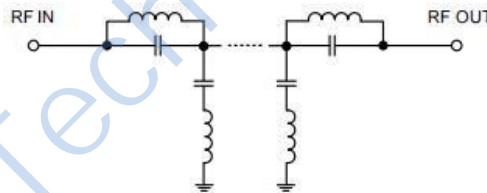

Outline Drawing

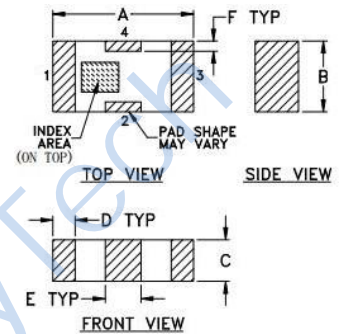

PCB Land Pattern

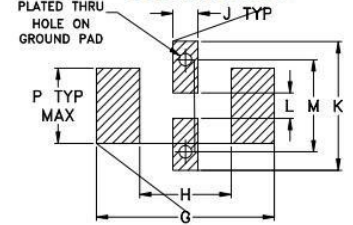

Suggested Layout
Tolerance to be within ±0.02

Outline Dimensions: Unit (mm)						
A	3.20	B	1.60	C	0.95	
D	0.51	E	0.81	F	0.23	
G	4.29	H	2.21	J	0.61	
K	3.10	L	0.61	M	2.21	
N	0.30	P	1.8	wt	0.02g	