

Antenna Datasheet

315Mhz SMD Chip Antenna

Model:

BW315MNX1304

Description:

315Mhz SMD Chip Antenna

Features:

315MHz Frequency Range

360° Omnidirectional Radiation

Dimensions: 13mm x 4.2 mm x 1.6mm

Compliant with RoHS & REACH Regulations



Contents

1.	Description	3
2.	Specifications	4
3.	Product Picture/ Drawing / Impedance Matching	5
4.	Evaluation Board Reference	6
5.	Testing Equipment	7-8
6.	Performance Data	9-10
	6.1 Return Loss	9
	6.2 Efficiency	9
7.	Radiation Patterns	10
	7.1 3D Radiation Patterns	10
	7.2 Recommended Reflow Profile	10
8.	Packaging	11
9.	Antenna Application Precautions	12
10.	Storage and Transportation Information	12



BW315MNX1304

Part Number Explanation

BW	Company	Bat Wireless
315	Frequency	315MHz
M	Name	SMD Chip Antenna
N	Type	Internal
X	Constant	X
1304	Package Dimensions	1304

1. Description

Bat Wireless BW315MNX1304 is an antenna commonly used in wireless communication. It features high integration for space-saving, with compactness and integration as its key attributes. The patch antenna is directly printed on the SMD, occupying minimal space and making it suitable for compact devices. It offers low cost: utilizing SMD technology for one-time fabrication, it requires no additional antenna components, thus being ideal for mass production. This antenna is suitable for miniaturized devices and widely applied in modules such as IoT, consumer electronics, and industrial equipment.

Classic Application Scenarios:

Consumer Electronics: Remote controls, smart home devices

IoT Devices: Smart meters, trackers

Industrial Equipment: Remote monitoring terminals, vehicle-mounted communication modules

Bat Wireless provides customized services to optimize your equipment. We have a mature R&D team that can respond quickly to meet your needs. If you have any requirements, please contact our sales and FAE.



2. Specification

Parameters	Typ.	Unites	Notes
Electrical Characteristics			
Antenna Type	SMD Chip Antenna		
Frequency Range	315±5	MHz	
Input Impedence	50	Ω	
V.S.W.R	<2.5		
Gain	1	dBi	
Polarization Type	Vertical		
Power Capacity	50	W	
Lightning Protection	-		
DC Voltage	-	V	
Radiator	-		
Mechanical Characteristics			
Dimensions	13 x 4.2 x 1.6	mm	
Connector Type	-		
Cable Type	-		
Cable Length	-	mm	
Mount way	SMD		
Color	Orange yellow		
Meterial	PCB		
Weight	0.2	g	
Environmental Characteristics			
Waterproof Rating	-		
ROHS Complaint	Compliant		
Operating Temperature	-45~ +85	°C	
Storage Temperature	-45~ +85	°C	

3. Product Picture/ Drawing / Impedance Matching

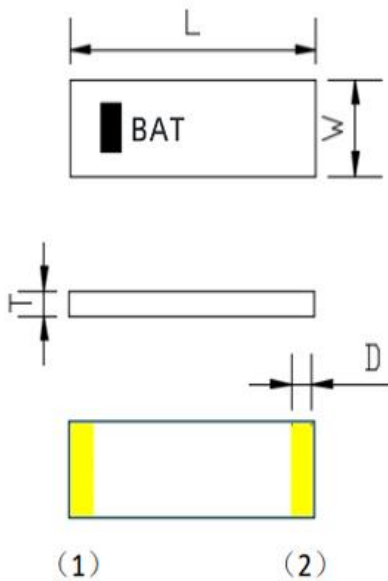
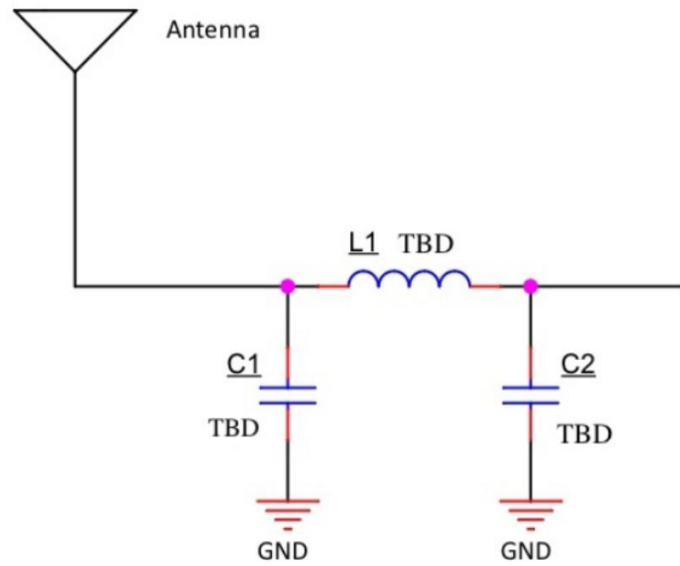
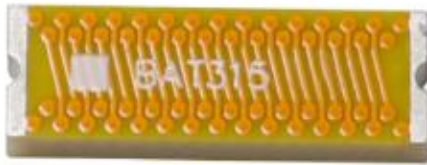

Dimension (mm)	
L	13.0 ± 0.15
W	4.2 ± 0.15
T	1.6 ± 0.15
A	1.0 ± 0.15

No.	Terminal Name
1	Feeding
2	grounding

4. Evaluation Board Reference

PCB Dimension

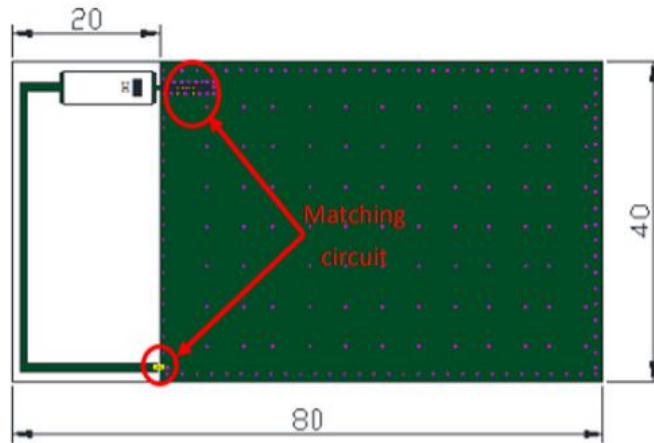

Antenna Layout Reference

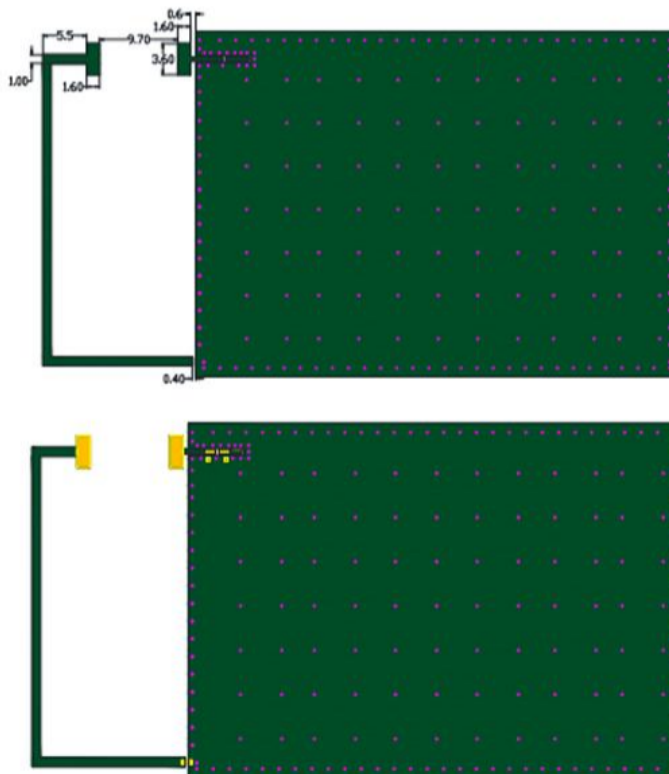

Unit : mm

 : Chip Antenna
 : Land Pattern

5. Test Equipment



Keysight/E5071C Network Analyzer



R&S/CMW500 Comprehensive Tester



R&S/SMBV100B Signal Generator

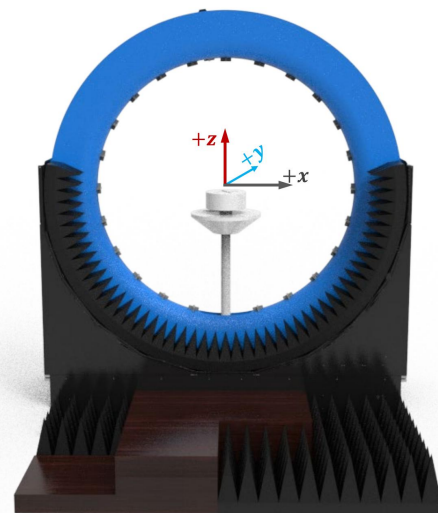

DT-3500 Datasheet

Specification:

Specification:	Description
Test Frequency	400MHz-8.5GHz
System Size	L*W*H=4*3.5*3.5m
Number of Probes	23 (Probe) + 1 (link)
Interval Angle	15°
Sampling Diameter	2200mm
Carring Capacity	≤40kg

Testing Capability

Description

Active measurement

Capability : TRP、TIS、EIRP、EIS,. etc
Mode : 2G/3G/4G/5G、Wi-Fi b/g/n/a/ac/ax、BT、NB-IOT、Cat-M (eMTC)、GPS/BEIDOU/GLONASS、ZigBee、LoRa(Non-Signaling),.etc

Passive measurement

Test category : Gain、Efficiency、2D pattern、3D pattern、Pattern roundness、Axial Ratio、ECC,Phase center,. etc
Polarization : Circular polarization, linear polarization, elliptical polarization



RF Link diaram of multi probe spherical near-field testing system

RF Link Overview



RF Link of Passive measurement



RF Link Overview



RF Link of Passive measurement



6. Performance Data

6.1 Return Loss

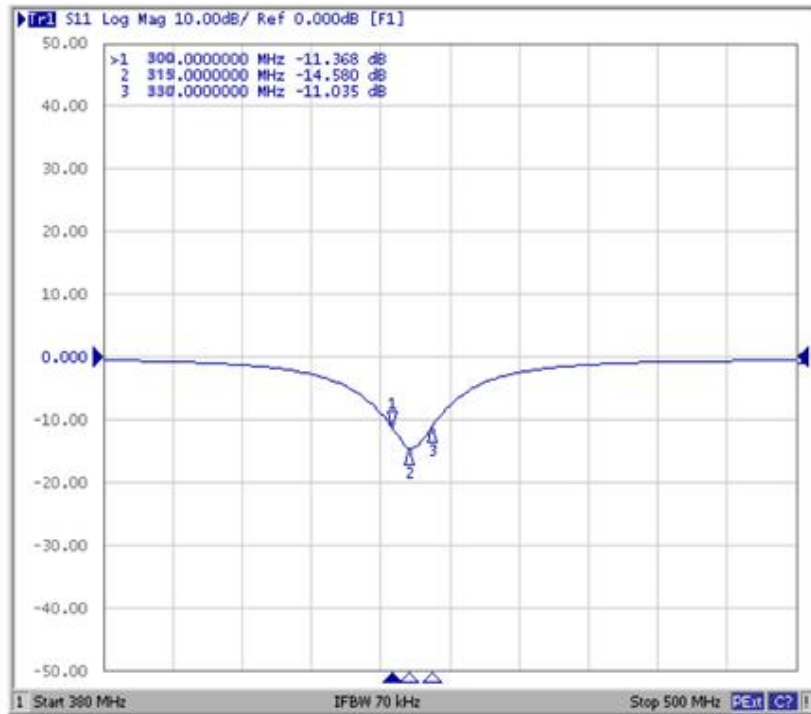

6.2 Efficiency

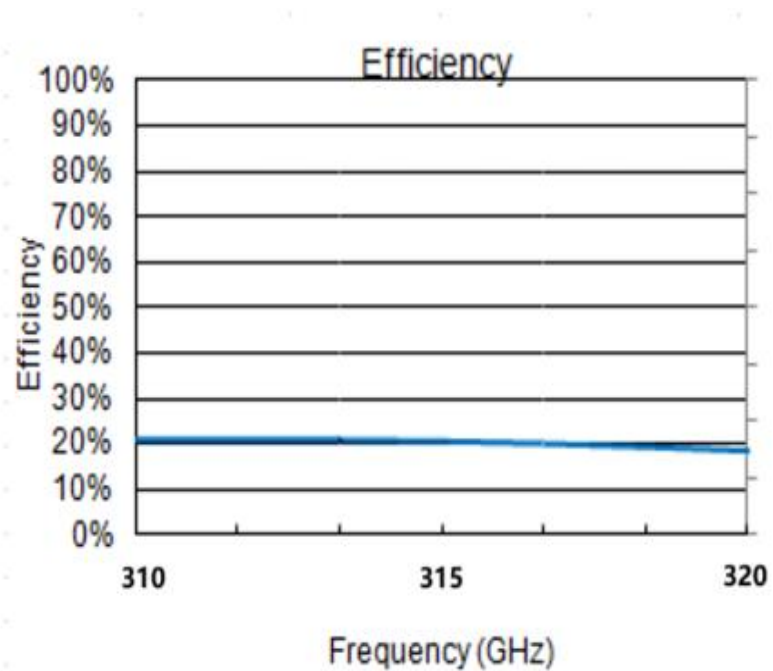

7. Radiation Patterns

7.1 3D Radiation Patterns

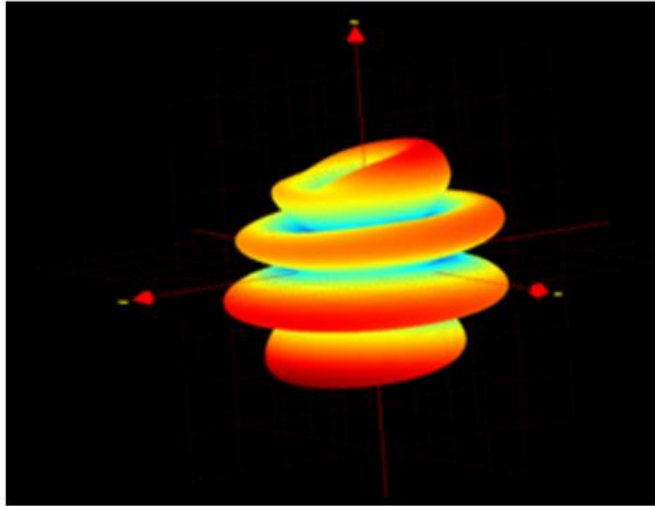

7.2 Recommended Reflow Profile

Pb free solder

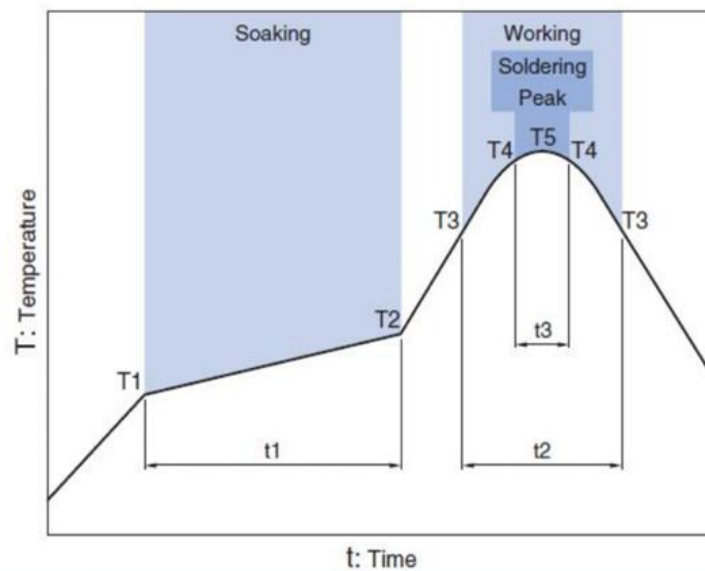

Soaking			Working		Soldering		Peak
Temp.		Time	Temp.	Time	Temp.	Time	Temp.
T1	T2	t1	T3	t2	T4	t3	T5
150°C	180°C	60 to 120sec	230°C	more than 30sec	247 to 253°C	within 10sec	260°C Max.

8. Packaging

Material Receiving Direction

REV	CHANGE CONTENT	DRAWN	DATE
A1	First Release	MARTIN	2025/4/19

Technical Requirements:

1. Material: PS, black anti-static, surface resistance: $10^9 \sim 10^{11} \Omega$.
2. Unspecified angles in the drawing shall be $3^\circ \sim 5^\circ$; maximum unspecified inner diameter is 0.2 mm.
3. The curvature of the carrier tape shall not exceed 1 mm per 250 mm.
4. The cumulative tolerance for 10 sprocket hole pitches shall be ± 0.20 mm.
5. All dimensions shall comply with the EA-481-E standard requirements.
6. Deformation, burrs, cracks, joints, or other defects are not allowed.
7. The dimensions of \blacktriangleright must be measured during first-article inspection.
8. Unless otherwise specified, unmarked dimensions are for reference only.
9. The product shall comply with RoHS environmental standards.
10. Modified areas must be indicated with \triangle .

QUALITY SYMBOLS	GENERAL TOLERANCES (UNLESS SPECIFIED)	DIMENSION STYLE	SCALE	REGION UNITS METRIC	THIRD ANGLE PROJECTION
$\blacktriangleright = 11$	MM	MM ONLY	2:1		
$\blacktriangle = 0$	X, X.X, X.XX, ± 0.20 , ± 0.10 , ± 0.05	DATE			
	ANGULAR	DRAWN BY: Mark			
		CHECKED BY: Mark			
		DATE: 2025/4/19			
		APPROVED BY: Jason			
		DATE: 2025/4/19			

PACKING INFORMATION	
Reel Type	330MM Light Blue Split Reel
Reel Dimension	330*100*24MM
Length per Reel	24,768 Meter/Reel
Pockets per Reel	3096 Pockets
Final Pocket Count	3009CS*Total 90 empty pockets removed (loading + trailing)
Protective Tape	N/A

TODDLING INFORMATION	
Mold Cavity Number	258 Shots
X-Cavity Mold	12-up tool 98mm Mold Length

DRAFT WHERE APPLICABLE WITHIN DIMENSIONS	
MATERIAL NO.	6011004941
TODDLING NO.	M-1614941-FP
DOCUMENT NO.	E-6011004941-01
SIZE	A4
SHEET NO.	1 OF 1



9. Antenna Application Precautions

1. If space permits, it is advisable not to choose antennas with too small dimensions.
2. It is best to have a large clearance area between the antenna and nearby objects; otherwise, matching adjustment will become difficult, and the radiation pattern will be severely distorted.
3. There should be no circuit layout or ground plane beneath the antenna.
4. The antenna should not be placed too close to metal objects, such as batteries and chips, and should not overlap with metal objects like batteries.
5. Note that internal cables (such as battery power cables) should preferably not be too close to the antenna.
6. A monopole antenna requires a reasonable ground plane to achieve optimal performance.
7. Performing antenna matching on the final product solution can shorten the adjustment cycle; whereas on a bare board, repeated adjustments are often needed.
8. Without matching, the same antenna placed on completely different layout boards may not work properly.
9. Do not use a metal housing or a plastic housing with metal covering around the antenna.
10. Do not use very thin antenna feeder wires; the feeder should have a certain width, not less than 0.1mm.
11. Calculate the feeder impedance based on the thickness and dielectric constant of the PCB; 50 ohms will make antenna adjustment easier.
12. Chip antennas should be assembled as far as possible from batteries, EMI shielding materials, foldable speakers, metal nails, LCD screens, etc.

10. Storage and Transportation Information

Storage Conditions

To ensure the solderability of terminal electrodes:

Temperature and humidity requirements: -10~40°C, relative humidity 30~70%.

Recommended service life: Use up within 6 months from the date of delivery.

Packaging storage environment: Should be placed in an air environment free of chlorine and sulfur. Transportation Conditions Handle with care to avoid product damage caused by collision or contamination from sweat, skin oils, etc.

Transportation Conditions

Handle with care to avoid product damage caused by collision or contamination from sweat, skin oils, etc.

Handling Recommendations: It is strongly recommended to use tweezers or a vacuum pen to pick up individual components.

Requirements for bulk handling: Friction and mechanical impact should be minimized.



DECLARATION:

Legal Notice: In order to provide users with better service, Shenzhen Bat Wireless Technology Co., Ltd. (hereinafter referred to as ' Bat Wireless') will endeavour to present users with detailed and accurate product information in this manual. However, due to the time-sensitive nature of the content in this manual, Bat Wireless cannot guarantee the timeliness and applicability of this document at all times. Bat Wireless reserves the right to update the content of this manual without prior notice. To obtain the latest information, we kindly request users to regularly visit the Bat Wireless official website or contact Bat Wireless staff. Thank you for your understanding and support!

Copyright Notice: All content in this product manual (including text, charts, logos, and designs) is protected by copyright law and international copyright treaties. No entity or individual may reproduce, modify, distribute, or use any part or all of this manual in any form (including electronic, mechanical, photocopying, etc.) without prior written authorisation from our company. Infringers will be held legally liable. All rights reserved.

Trademark Notice: All product names and corporate logos of Bat Wireless mentioned in this manual are the lawful property of our company (including affiliated companies). Unauthorised use, reproduction, or imitation is strictly prohibited. Third-party trademarks referenced in this manual are the property of their respective owners, and their use is solely for illustrative purposes and does not imply any commercial affiliation or authorisation. Our company reserves all rights to pursue legal action against any infringement.

Disclaimer: The product information contained in this manual is for reference only. Actual product performance may vary depending on the usage environment and configuration differences. Our company makes no express or implied warranties regarding the accuracy, completeness, or applicability of the content of this manual and shall not be liable for any direct or indirect losses arising from the use or inability to use the content of this manual. Users should assess the applicability of the product and follow actual operating procedures. The final interpretation of this manual is reserved by our company.

Shenzhen Bat Wireless Technology Co.,Ltd

Office Add: Room 1301, 13th Floor, No. 8 Langhua Road, Xinshi Community, Dalang Street, Longhua District, Shenzhen

Email: marketing@batwireless.com

Tel: 0755-21031236



Documentation

Version :	August-21-2025-A01
Date :	2025-8-21
Remarks :	First update
Author:	Carly

Change Log
