

1.5KE Series

Transient Voltage Suppressor

Features

- Excellent clamping capability
- Low leakage current
- Low capacitance
- High surge capability
- Glass passivated chip
- Epoxy resin package
- Built-in strain relief
- Will not fatigue
- RoHS Compliant
- Fast response time: typically less than 1.0ps from 0 Volts to VBR min

Package

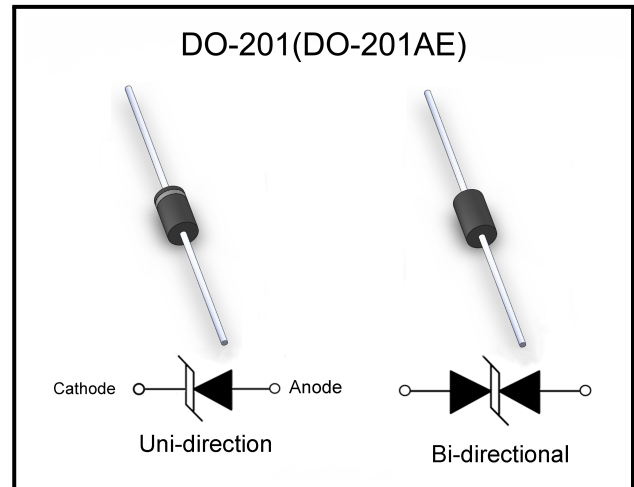

Mechanical Characteristics

- Package: DO-201 plastic package.
- Lead Finish: Matte Tin
- Case Material: Epoxy Molding Compound.
- UL Flammability Classification Rating 94V-0
- Moisture Sensitivity: Level 1 per J-STD-020

Applications

- Telecom
- Computer
- Industrial electronic
- Consumer electronic

Making Code

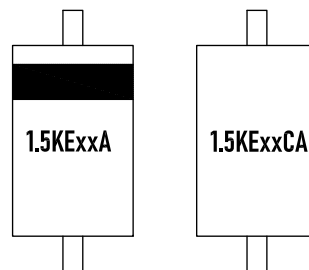

Summary of Packing Options

Package	Packing Description	Packing Quantity	Industry Standard
DO-201	Tape/Box,Box	1000	BORN SPEC
	Tape/Reel,13" reel	1200	EIA STD RS-296



1.5KE Series

Transient Voltage Suppressor

Electrical Parameters

Parameter	Definition
C_J	Junction Capacitance - typical capacitance measured with 0V or V_R bias
I_{PP}	Peak Pulse Current - maximum rated peak impulse current
V_C	Clamping Voltage - Peak voltage measured across the suppressor at a specified I_{ppm}
V_{BR}	Breakdown Voltage - Maximum voltage that flows though the TVS at a specified test current (I_T)
I_R	Leakage Current - maximum peak off-state current measured at V_R
V_R	Peak Off-state Voltage - maximum voltage that can be applied while maintaining off state

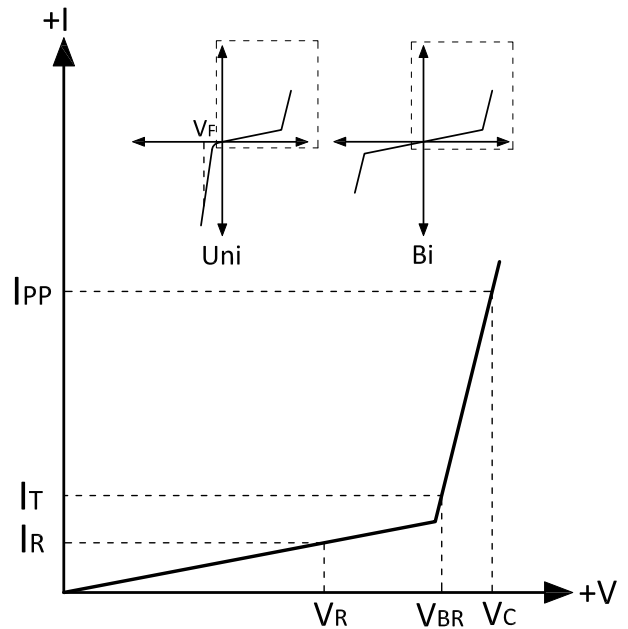

Absolute Maximum Ratings ($T_A=+25^\circ\text{C}$, unless otherwise noted)

Parameter	Symbol	Value	Units
Peak Pulse Power Dissipation(Note1)	P_{PPM}	1500	W
Steady State Power Dissipation (Note2)	P_D	6.5	W
Peak Forward Surge Current (Note3)	I_{FSM}	200	A
Maximum Instantaneous Forward Voltage at 100A (Note4)	V_{FM}	3.5/5	V
Typical Thermal Resistance Junction to Lead	$R_{\theta JL}$	15	$^\circ\text{C/W}$
Typical Thermal Resistance Junction to Ambient	$R_{\theta JA}$	75	$^\circ\text{C/W}$
Operating Junction Temperature Range	T_J	-55 to 150	$^\circ\text{C}$
Storage Temperature Range	T_{SJG}	-55 to 150	$^\circ\text{C}$

Notes:

- (1) Non-repetitive current pulse , 10/1000us Waveform.
- (2) Infinite Heat Sink at $T_L=75^\circ\text{C}$, at 0.375"(9.5mm) lead length, P.C.B. mounted.
- (3) Measured on 8.3ms single half sine wave or equivalent square wave, duty cycle=4 per minute maximum.
- (4) For Unidirectional only, $V_{FW}<3.5\text{V}$ for $V_{BR} \leq 200\text{V}$ and $V_{FM}<5.0\text{V}$ for $V_{BR} \geq 201\text{V}$.



1.5KE Series

Transient Voltage Suppressor

Absolute Maximum Ratings ($T_A=+25^{\circ}\text{C}$, unless otherwise noted)

Part Number		Reverse Stand-Off Voltage V_R	Breakdown Voltage $V_{BR}@ I_T$		Test Current I_T	Maximum Clamping Voltage $V_C@ I_{pp}$	Maximum Peak Pulse Current I_{pp}	Maximum Reverse Leakage $I_R@ V_R$
(Uni)	(Bi)	(V)	Min.(V)	Max.(V)	(mA)	(V)	(A)	(μA)
1.5KE6.8A	1.5KE6.8CA	5.8	6.45	7.14	10	10.5	144.8	1000
1.5KE7.5A	1.5KE7.5CA	6.4	7.13	7.88	10	11.3	134.5	500
1.5KE8.2A	1.5KE8.2CA	7.02	7.79	8.61	10	12.1	125.6	200
1.5KE9.1A	1.5KE9.1CA	7.78	8.65	9.5	1	13.4	113.4	50
1.5KE10A	1.5KE10CA	8.55	9.5	10.5	1	14.5	104.8	10
1.5KE11A	1.5KE11CA	9.4	10.5	11.6	1	15.6	97.4	5
1.5KE12A	1.5KE12CA	10.2	11.4	12.6	1	16.7	91.0	5
1.5KE13A	1.5KE13CA	11.1	12.4	13.7	1	18.2	83.5	1
1.5KE15A	1.5KE15CA	12.8	14.3	15.8	1	21.2	71.7	1
1.5KE16A	1.5KE16CA	13.6	15.2	16.8	1	22.5	67.6	1
1.5KE18A	1.5KE18CA	15.3	17.1	18.9	1	25.2	60.3	1
1.5KE20A	1.5KE20CA	17.1	19	21	1	27.7	54.9	1
1.5KE22A	1.5KE22CA	18.8	20.9	23.1	1	30.6	49.7	1
1.5KE24A	1.5KE24CA	20.5	22.8	25.2	1	33.2	45.8	1
1.5KE27A	1.5KE27CA	23.1	25.7	28.4	1	37.5	40.5	1
1.5KE30A	1.5KE30CA	25.6	28.5	31.5	1	41.4	36.7	1
1.5KE33A	1.5KE33CA	28.2	31.4	34.7	1	45.7	33.3	1
1.5KE36A	1.5KE36CA	30.8	34.2	37.8	1	49.9	30.5	1
1.5KE39A	1.5KE39CA	33.3	37.1	41	1	53.9	28.2	1
1.5KE43A	1.5KE43CA	36.8	40.9	45.2	1	59.3	25.6	1
1.5KE47A	1.5KE47CA	40.2	44.7	49.4	1	64.8	23.5	1
1.5KE51A	1.5KE51CA	43.6	48.5	53.6	1	70.1	21.7	1
1.5KE56A	1.5KE56CA	47.8	53.2	58.8	1	77	19.7	1
1.5KE62A	1.5KE62CA	53	58.9	65.1	1	85	17.9	1
1.5KE68A	1.5KE68CA	58.1	64.6	71.4	1	92	16.5	1
1.5KE75A	1.5KE75CA	64.1	71.3	78.8	1	103	14.8	1
1.5KE82A	1.5KE82CA	70.1	77.9	86.1	1	113	13.5	1
1.5KE91A	1.5KE91CA	77.8	86.5	95.5	1	125	12.2	1
1.5KE100A	1.5KE100CA	85.5	95	105	1	137	11.1	1
1.5KE110A	1.5KE110CA	94	105	116	1	152	10.0	1



1.5KE Series

Transient Voltage Suppressor

Absolute Maximum Ratings ($T_A=+25^{\circ}\text{C}$, unless otherwise noted)

Part Number		Reverse Stand-Off Voltage V_R	Breakdown Voltage $V_{BR}@ I_T$		Test Current I_T	Maximum Clamping Voltage $V_C@ I_{pp}$	Maximum Peak Pulse Current I_{pp}	Maximum Reverse Leakage $I_R@ V_R$
(Uni)	(Bi)	(V)	Min.(V)	Max.(V)	(mA)	(V)	(A)	(μA)
1.5KE120A	1.5KE120CA	102	114	126	1	165	9.2	1
1.5KE130A	1.5KE130CA	111	124	137	1	179	8.5	1
1.5KE150A	1.5KE150CA	128	143	158	1	207	7.3	1
1.5KE160A	1.5KE160CA	136	152	168	1	219	6.9	1
1.5KE170A	1.5KE170CA	145	162	179	1	234	6.5	1
1.5KE180A	1.5KE180CA	154	171	189	1	246	6.2	1
1.5KE200A	1.5KE200CA	171	190	210	1	274	5.5	1
1.5KE220A	1.5KE220CA	185	209	231	1	328	4.6	1
1.5KE250A	1.5KE250CA	214	237	263	1	344	4.4	1
1.5KE300A	1.5KE300CA	256	285	315	1	414	3.7	1
1.5KE320A	1.5KE320CA	273	304	336	1	441	3.5	1
1.5KE350A	1.5KE350CA	300	332	368	1	482	3.2	1
1.5KE400A	1.5KE400CA	342	380	420	1	548	2.8	1
1.5KE440A	1.5KE440CA	376	418	462	1	602	2.5	1
1.5KE480A	1.5KE480CA	408	456	504	1	658	2.3	1
1.5KE510A	1.5KE510CA	434	485	535	1	698	2.1	1
1.5KE530A	1.5KE530CA	477	503.5	556.5	1	725	2.1	1
1.5KE540A	1.5KE540CA	486	513	567	1	740	2.0	1
1.5KE550A	1.5KE550CA	495	522.5	577.5	1	760	2.0	1
1.5KE600A	1.5KE600CA	512	570	630	1	828	1.8	1





1.5KE Series

Transient Voltage Suppressor

Ratings and Characteristic Curves ($T_A = +25^\circ\text{C}$, unless otherwise noted)

Figure 1: Peak Pulse Power Rating

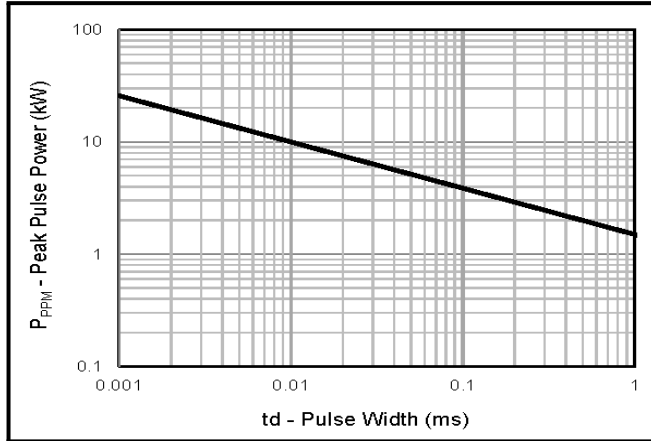

Figure 2: Pulse Derating Curve

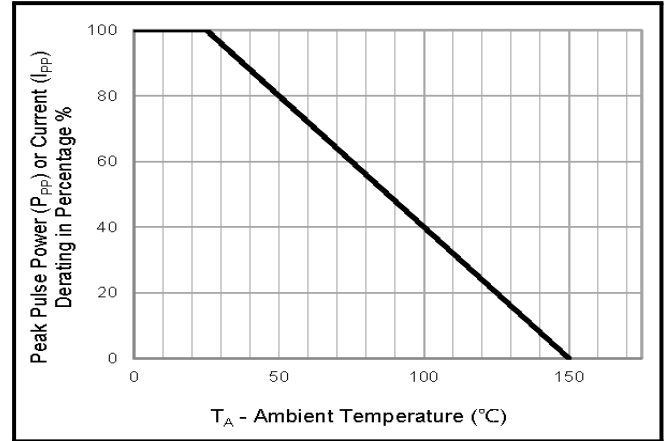

Figure 3: Pulse Waveform

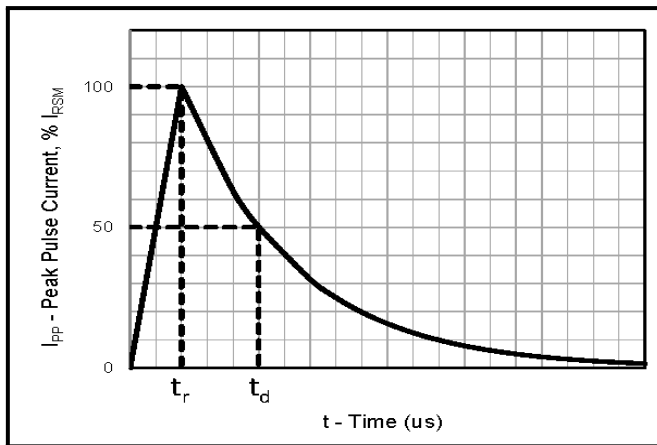

Figure 4: Typical Junction Capacitance

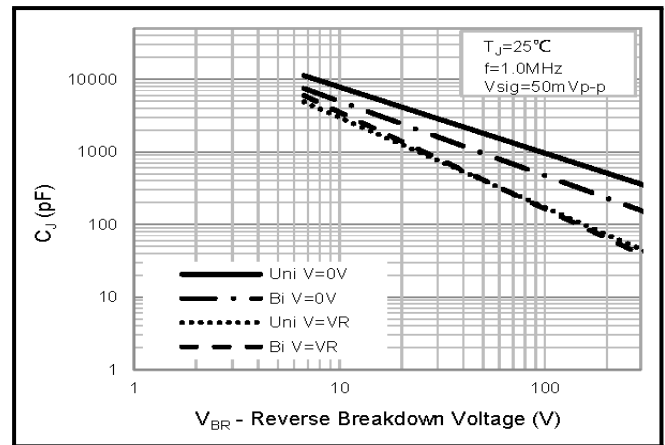

Figure 5: Steady State Power Dissipation Derating

Curve

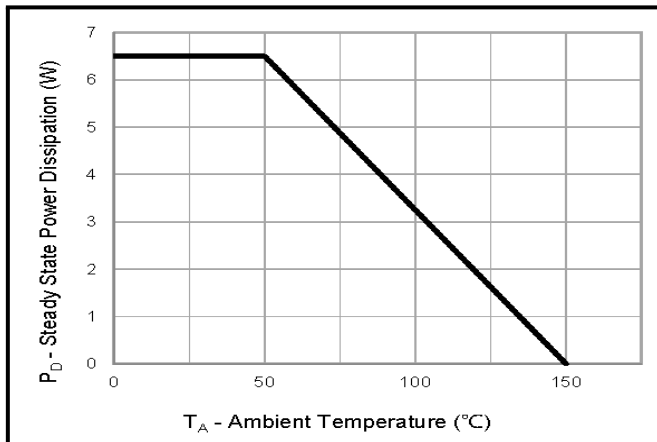
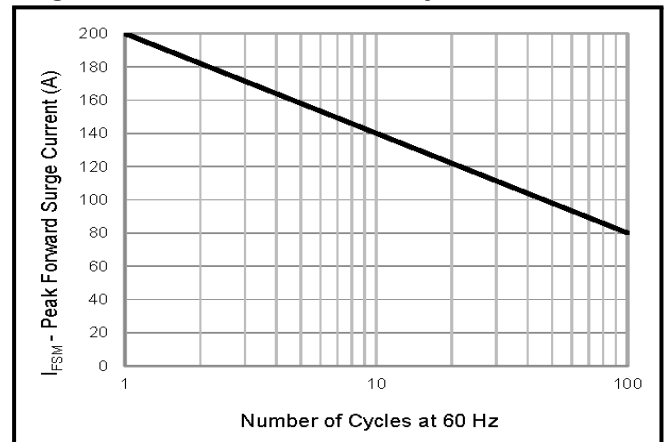

Figure 6: Maximum Non-Repetitive Peak Forward

Surge Current Uni-Directional Only



1.5KE Series

Transient Voltage Suppressor

Soldering Parameters

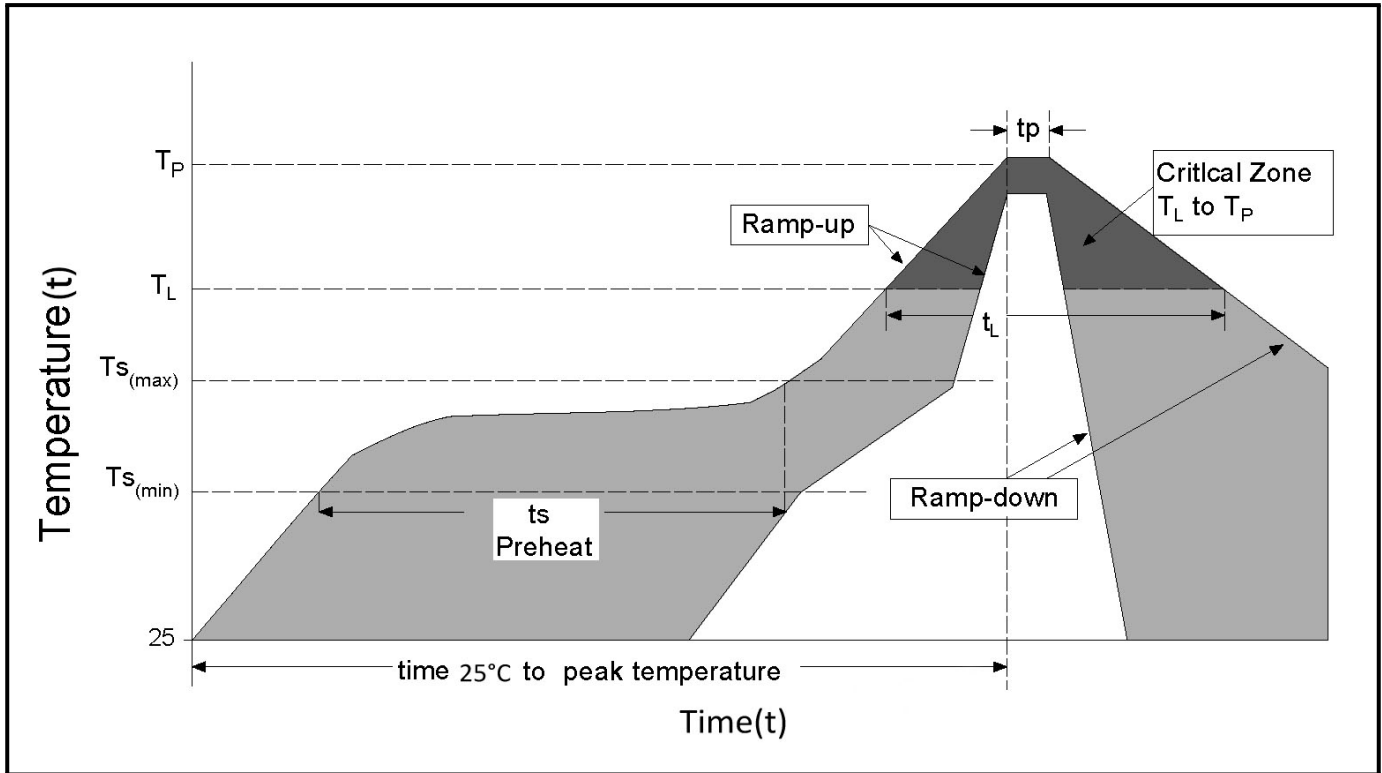

Reflow Condition		Lead-free assembly
Pre Heat	- Temperature Min ($T_{S(min)}$)	150°C
	- Temperature Max ($T_{S(max)}$)	200°C
	- Time (min to max) (t_s)	60 - 180 secs
Average ramp up rate (Liquidus Temp (T_L) to peak)		3°C/second max
$T_{S(max)}$ to T_L - Ramp-up Rate		3°C/second max
Reflow	- Temperature (T_L) (Liquidus)	217°C
	- Time (t_L)	60 - 150 secs
Peak Temperature (T_P)		260 ^{+0/-5} °C
Time within 5°C of actual peak Temperature (t_p)		20 - 40 secs
Ramp-down Rate		6°C/second max
Time 25°C to peak Temperature (t)		8 minutes Max.
Do not exceed		260°C



1.5KE Series

Transient Voltage Suppressor

Package Mechanical Data - DO-201

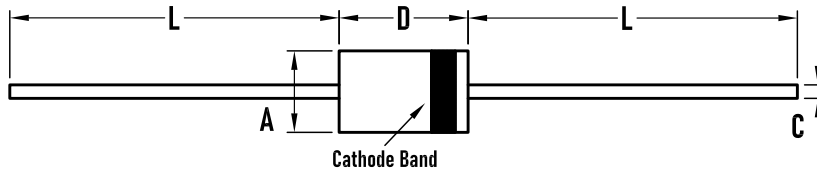

SYMBOL	Inches		MILLIMETER	
	MIN	MAX	MIN	MAX
A	0.189	0.209	4.8	5.3
C	0.038	0.051	0.96	1.30
D	0.283	0.374	7.2	9.5
L	1	-	25.4	-

Packaging Tape - DO-201

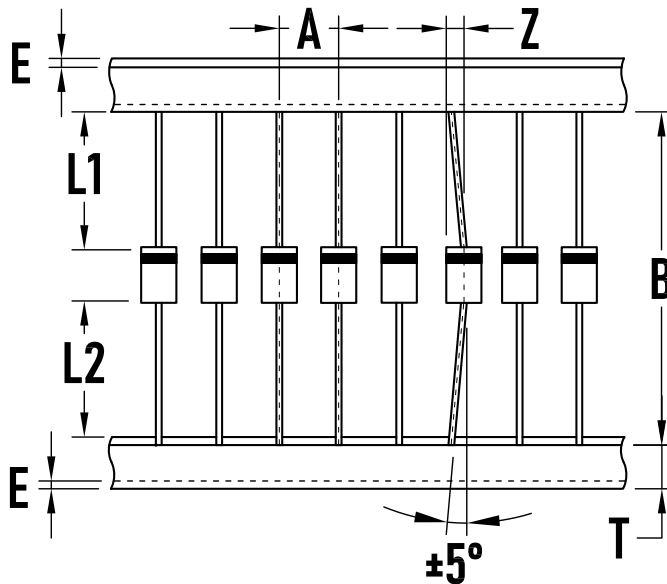

SYMBOL	Dimension(mm)
A	10.0±0.5
B	53.0±1.0
Z	1.2Max.
T	6.0±0.4
E	0.8Max.
L1-L2	1.0Max.

Packaging Reel

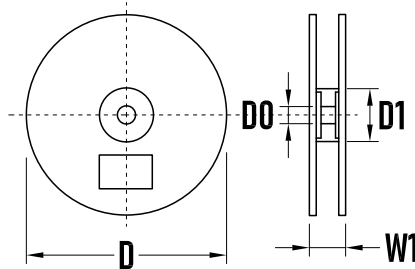

SYMBOL	Dimension(mm)
D	330.0±3.0
D0	16.4±2.0
D1	86.0±2.0
W1	76.0±3.0
Quantity	1200PCS

Packaging BOX

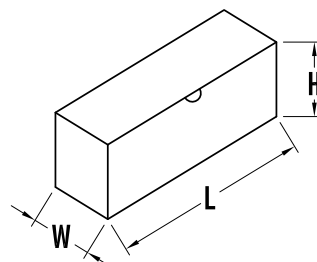

SYMBOL	Dimension(mm)
L	250.0±5.0
W	75.0±5.0
H	114.0±5.0
Quantity	1000PCS

