

标记 MARK	ECN编号/变更内容 ECN NO/DEFINITION	修改 REVISE	日期 DATE	核准 APPROVE

Number of Contacts	Dimension				
	A	B	C	D	E
11	4.80	2.40	3.00	3.65	4.30
13	5.40	3.00	3.60	4.25	4.90
15	6.00	3.60	4.20	4.85	5.50
17	6.60	4.20	4.80	5.45	6.10
19	7.20	4.80	5.40	6.05	6.70
21	7.80	5.40	6.00	6.65	7.30
23	8.40	6.00	6.60	7.25	7.90
25	9.00	6.60	7.20	7.85	8.50
27	9.60	7.20	7.80	8.45	9.10
29	10.20	7.80	8.40	9.05	9.70
31	10.80	8.40	9.00	9.65	10.30
33	11.40	9.00	9.60	10.25	10.90
35	12.00	9.60	10.20	10.85	11.50
37	12.60	10.20	10.80	11.45	12.10
39	13.20	10.80	11.40	12.05	12.70
41	13.80	11.40	12.00	12.65	13.30
45	15.00	12.60	13.20	13.85	14.50
49	16.20	13.80	14.40	15.05	15.70
51	16.80	14.40	15.00	15.65	16.30

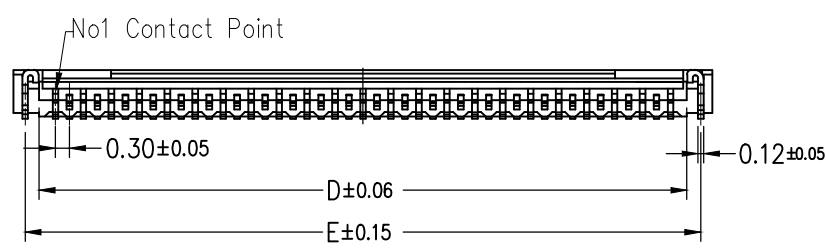

- Note:
- Material
 - Housing: LCP Color: Natural
 - Actuator: LCP OR PA Color: Black
 - Contact: Phosphor Bronze.
 - LEG: Phosphor Bronze.
 - Plating
 - Contact: See Part Number.
 - LEG: Matte Tin Plating Over Nickel.
 - Rating:
 - Operating Voltage: 30V AC/DC.
 - Current Rating: 0.2A AC/DC.
 - Operating Temperature: -55°C~+85°C.

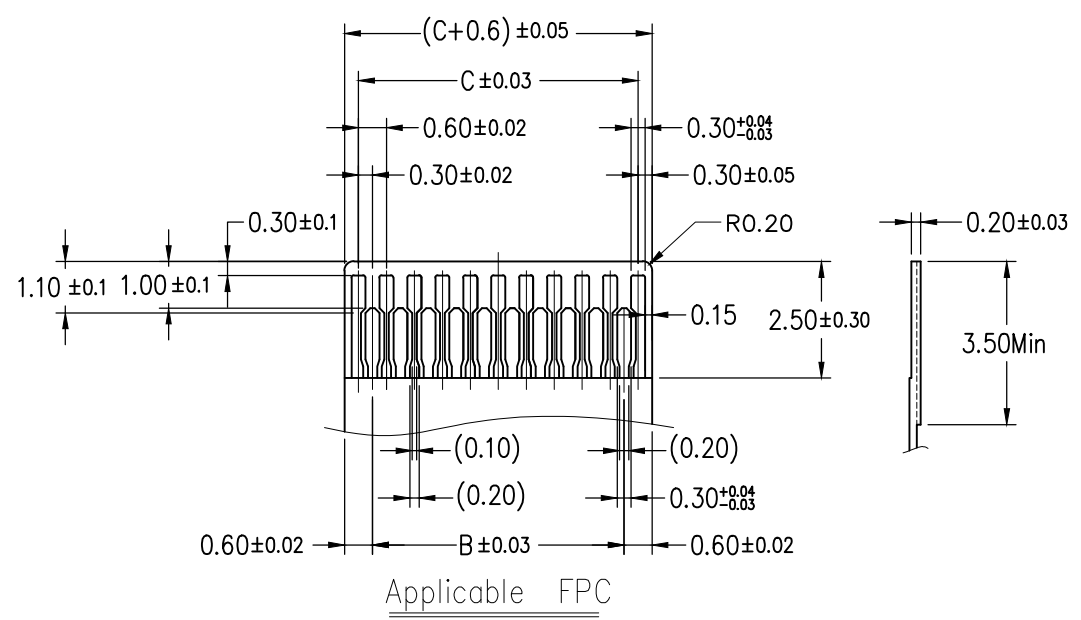
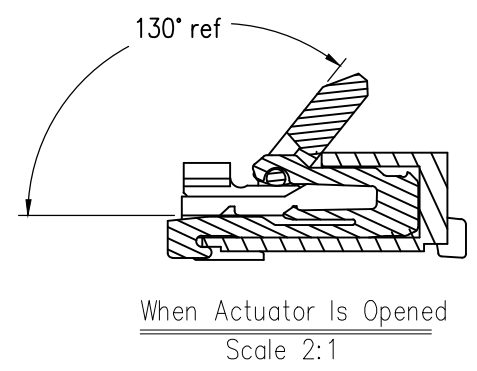
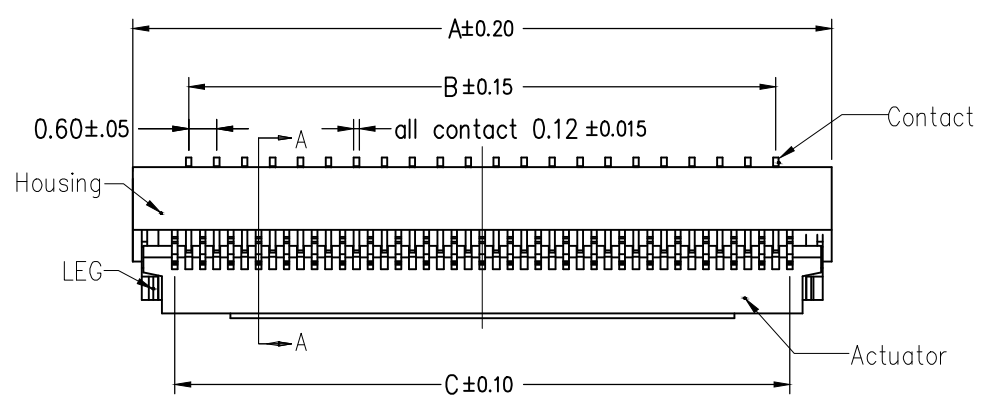
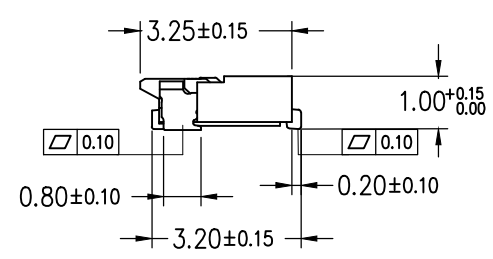
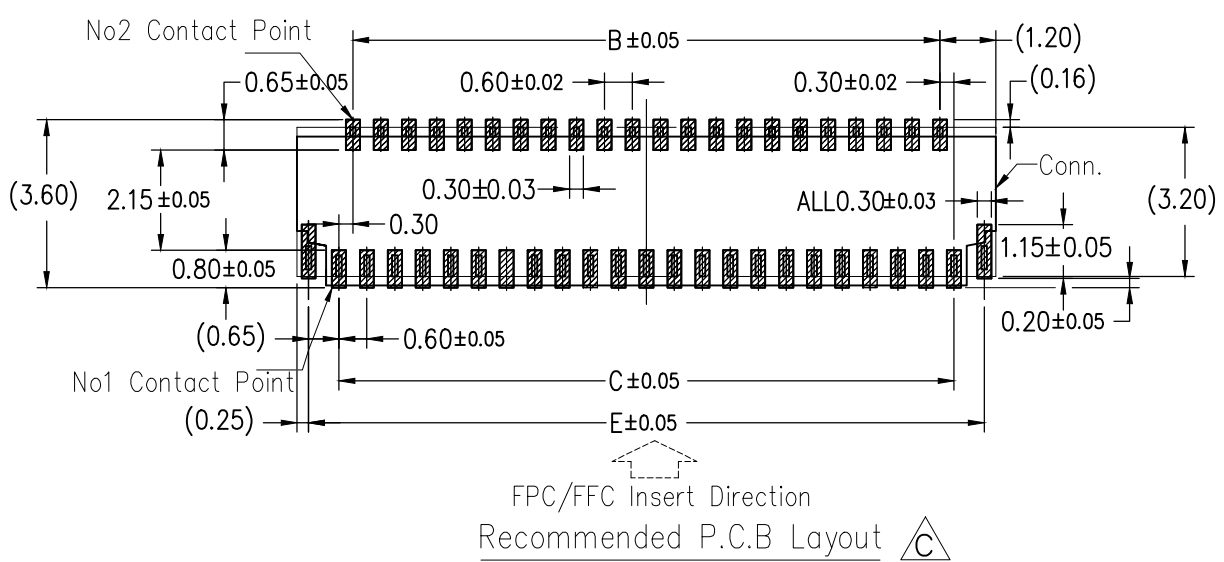

2	端子	铜	点镀金	
1	基座	LCP	本色	
序号	品名	材质	电镀/颜色	备注

深圳市虹成电子有限公司
 品名 TITLE: FPC座
 料号 PART NO: HC-FPC-0.3-17P-FH10

GENERAL TOLERANCES (UNLESS SPECIFIED)	比列 SCALE: 1:1	制图 DRAW: AhYe	
x.x : ±0.30 x.x* : ±5*	单位 UNIT: MM	审核 CHECKED: 夏操云	
x.xx : ±0.20 x.xx* : ±2*	张数 PART NO: 1 OF 1	批准 APPROVE: 赵亮亮	
x.xxx : ±0.10 x.xxx* : ±1*	版本 REV: A		