

➤ **Features**

- Size 0.29*0.20 inch /7.5*5.5 mm
- RoHS compliant, lead-free and halogen-free
- Fast response to fault current
- Low resistance
- Low profile
- Compatible with high temperature solders

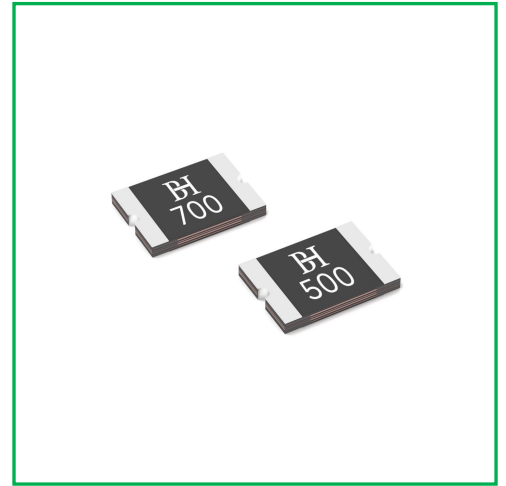

➤ **Applications**

- Computer, Mobile phones, Multimedia
- Automotive, Industrial controls, Telephony and broadband
- Game machines, Portable electronics, Battery

➤ **Part Number System**

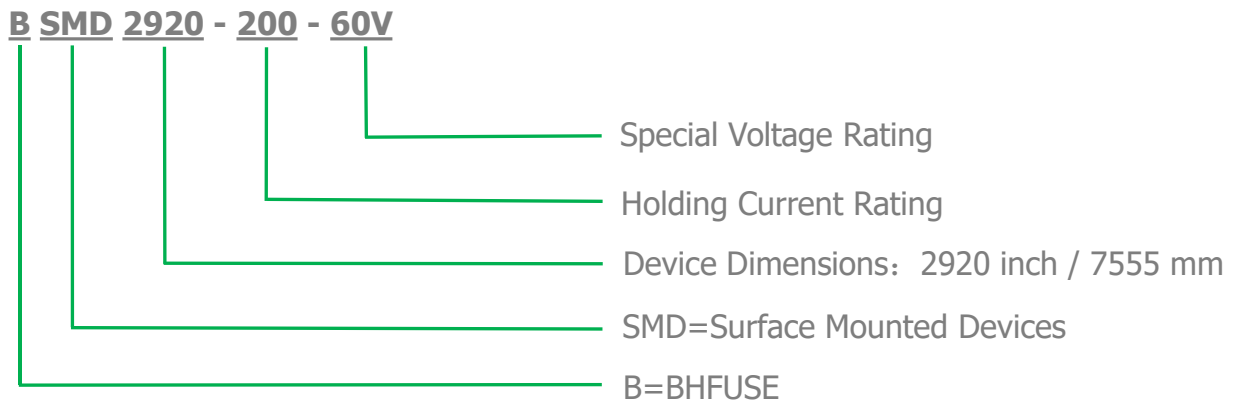

➤ **Electrical Characteristics (25°C)**

Part Number	I_{hold}	I_{trip}	V_{max}	I_{max}	P_d typ	Time to trip		R_{min}	$R1_{max}$
	(A)	(A)	(V _{dc})	(A)	(W)	(A)	(Sec)	(Ω)	(Ω)
BSMD2920-020-100V	0.20	0.40	100	40	1.8	1.00	5.0	0.750	8.000
BSMD2920-030-60V	0.30	0.60	60	40	1.8	1.50	3.0	0.600	4.800
BSMD2920-050-60V	0.50	1.00	60	40	1.8	2.50	4.0	0.180	1.400
BSMD2920-075-33V	0.75	1.50	33	40	1.8	8.00	0.3	0.100	1.000
BSMD2920-075-60V	0.75	1.50	60	40	1.8	8.00	0.3	0.100	1.000

Part Number	I_{hold}	I_{trip}	V_{max}	I_{max}	P_d typ	Time to trip		R_{min}	$R1_{max}$
	(A)	(A)	(V _{dc})	(A)	(W)	(A)	(Sec)	(Ω)	(Ω)
BSMD2920-100-33V	1.10	2.20	33	40	1.8	8.00	0.5	0.065	0.410
BSMD2920-100-60V	1.10	2.20	60	40	1.8	8.00	0.5	0.065	0.410
BSMD2920-100-72V	1.10	2.20	72	40	1.8	8.00	0.5	0.065	0.410
BSMD2920-125-33V	1.25	2.50	33	40	1.8	8.00	2.0	0.050	0.250
BSMD2920-150-33V	1.50	3.00	33	40	1.8	8.00	2.0	0.035	0.230
BSMD2920-150-48V	1.50	3.00	48	15	2.0	8.00	2.0	0.035	0.230
BSMD2920-150-60V	1.50	3.00	60	15	2.0	8.00	2.0	0.035	0.230
BSMD2920-185-33V	1.85	3.70	33	40	2.0	8.00	2.5	0.030	0.150
BSMD2920-200-16V	2.00	4.00	16	40	2.0	8.00	4.5	0.020	0.120
BSMD2920-200-24V	2.00	4.00	24	40	2.0	8.00	4.5	0.020	0.120
BSMD2920-200-30V	2.00	4.00	30	40	2.0	8.00	4.5	0.020	0.120
BSMD2920-200-33V	2.00	4.00	33	40	2.0	8.00	4.5	0.020	0.120
BSMD2920-200-36V	2.00	4.00	36	40	2.0	8.00	4.5	0.020	0.120
BSMD2920-200-48V	2.00	4.00	48	40	2.0	8.00	4.5	0.020	0.120
BSMD2920-200-60V	2.00	4.00	60	40	2.0	8.00	4.5	0.020	0.120
BSMD2920-250-16V	2.50	5.00	16	40	2.0	8.00	10	0.020	0.085
BSMD2920-250-24V	2.50	5.00	24	40	2.0	8.00	10	0.020	0.085
BSMD2920-250-30V	2.50	5.00	30	40	2.0	8.00	10	0.020	0.085
BSMD2920-250-33V	2.50	5.00	33	40	2.0	8.00	10	0.020	0.085
BSMD2920-260-6V	2.60	5.00	6	40	2.0	8.00	10	0.014	0.075
BSMD2920-260-16V	2.60	5.00	16	40	2.0	8.00	10	0.014	0.075
BSMD2920-260-24V	2.60	5.00	24	40	2.0	8.00	10	0.014	0.075
BSMD2920-300-6V	3.00	5.00	6	40	2.0	8.00	20	0.012	0.048
BSMD2920-300-16V	3.00	5.00	16	40	2.0	8.00	20	0.012	0.048
BSMD2920-300-24V	3.00	5.00	24	40	2.0	8.00	20	0.012	0.048
BSMD2920-300-30V	3.00	5.00	30	40	2.0	8.00	20	0.012	0.048
BSMD2920-300-33V	3.00	5.00	33	40	2.0	8.00	20	0.012	0.048
BSMD2920-300-36V	3.00	5.00	36	40	2.0	8.00	20	0.012	0.048
BSMD2920-330-16V	3.30	5.50	16	40	2.0	8.00	20	0.015	0.055
BSMD2920-330-24V	3.30	5.50	24	40	2.0	8.00	20	0.015	0.055
BSMD2920-330-30V	3.30	5.50	30	40	2.0	8.00	20	0.015	0.055
BSMD2920-330-33V	3.30	5.50	33	40	2.0	8.00	20	0.015	0.055
BSMD2920-400-6V	4.00	8.00	6	40	2.5	20.0	4	0.008	0.040
BSMD2920-400-12V	4.00	8.00	12	40	2.5	20.0	4	0.008	0.040
BSMD2920-400-16V	4.00	8.00	16	40	2.5	20.0	4	0.008	0.040
BSMD2920-400-24V	4.00	8.00	24	40	2.5	20.0	4	0.008	0.040
BSMD2920-400-30V	4.00	8.00	30	40	2.5	20.0	4	0.008	0.040
BSMD2920-500-6V	5.00	10.00	6	40	2.5	25.0	5	0.005	0.031
BSMD2920-500-12V	5.00	10.00	12	40	2.5	25.0	5	0.005	0.031
BSMD2920-500-16V	5.00	10.00	16	40	2.5	25.0	5	0.005	0.031

Part Number	I_{hold}	I_{trip}	V_{max}	I_{max}	$P_{d\ typ}$	Time to trip		R_{min}	R_{1max}
	(A)	(A)	(V _{dc})	(A)	(W)	(A)	(Sec)	(Ω)	(Ω)
BSMD2920-500-24V	5.00	10.00	24	40	2.5	25.0	5	0.005	0.031
BSMD2920-500-30V	5.00	10.00	30	40	2.5	25.0	5	0.005	0.031
BSMD2920-600-6V	6.00	12.00	6	40	2.5	25.0	6	0.004	0.020
BSMD2920-600-12V	6.00	12.00	12	40	2.5	25.0	6	0.004	0.020
BSMD2920-600-16V	6.00	12.00	16	40	2.5	25.0	6	0.004	0.020
BSMD2920-700-6V	7.00	14.00	6	40	2.5	25.0	6	0.0025	0.010
BSMD2920-700-12V	7.00	14.00	12	40	2.5	25.0	6	0.0025	0.010

➤ Vocabulary

I_{hold} = Hold current: maximum current device will pass without tripping in 25°C still air.

I_{trip} = Trip current: minimum current at which the device will trip in 25°C still air.

V_{max} = Maximum voltage device can withstand without damage at rated current (I_{max}).

I_{max} = Maximum fault current device can withstand without damage at rated voltage (V_{max}).

$P_{d\ typ.}$ = Typical power dissipated from device when in the tripped state at 25°C still air.

R_{min} = Minimum resistance of device in initial (un-soldered) state.

R_{1max} = Maximum resistance of device at 25°C measured one hour after tripping or reflow soldering of 260°C for 20 sec.

Caution: Operation beyond the specified ratings may result in damage and possible arcing and flame.

➤ **Thermal Derating Curve**

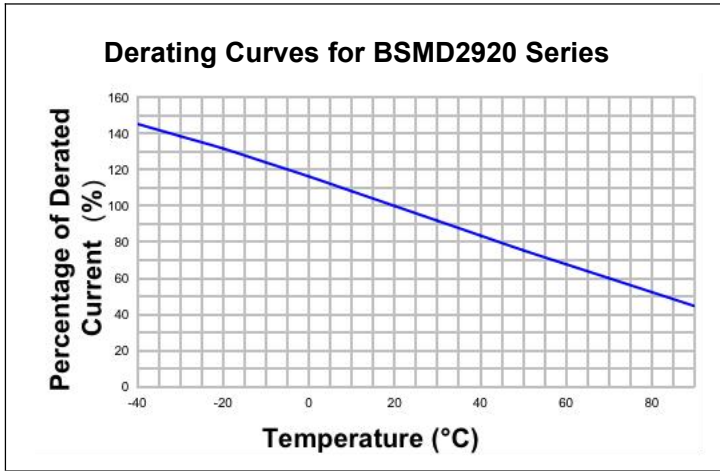

➤ **Average Time-Current Curve**

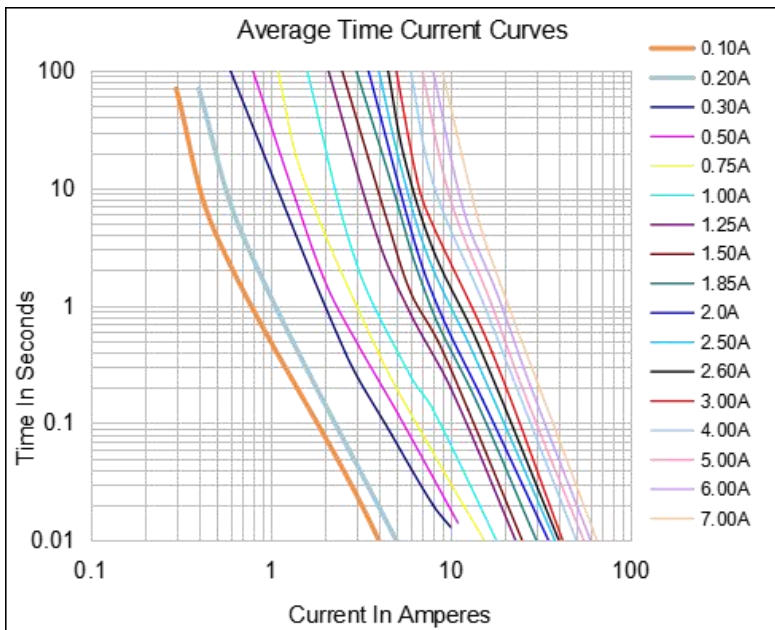

➤ Thermal Derating Chart

Part Number	Ambient operating temperature hold current(I_{hold})								
	-40°C	-20°C	0°C	25°C	40°C	50°C	60°C	70°C	85°C
BSMD2920-020	0.30	0.22	0.25	0.20	0.14	0.10	0.07	0.06	0.04
BSMD2920-030	0.45	0.40	0.35	0.30	0.25	0.23	0.20	0.17	0.14
BSMD2920-050	0.76	0.67	0.59	0.50	0.42	0.38	0.33	0.29	0.23
BSMD2920-075	1.13	1.01	0.88	0.75	0.62	0.56	0.50	0.44	0.34
BSMD2920-100	1.66	1.47	1.29	1.10	0.91	0.83	0.73	0.64	0.50
BSMD2920-125	1.89	1.68	1.46	1.25	1.04	0.94	0.83	0.73	0.56
BSMD2920-150	2.27	2.01	1.76	1.50	1.25	1.13	1.00	0.87	0.74
BSMD2920-185	2.80	2.47	2.17	1.85	1.54	1.39	1.22	1.07	0.85
BSMD2920-200	3.02	2.68	2.34	2.00	1.66	1.50	1.32	1.16	0.90
BSMD2920-250	3.64	3.25	2.91	2.50	2.08	1.88	1.65	1.45	1.13
BSMD2920-260	3.78	3.35	2.93	2.60	2.26	2.08	1.95	1.74	1.18
BSMD2920-300	4.53	4.02	3.51	3.00	2.52	2.26	1.99	1.79	1.34
BSMD2920-330	4.60	4.20	3.75	3.30	2.95	2.75	2.50	2.25	1.70
BSMD2920-400	6.04	5.36	4.68	4.00	3.36	3.01	2.65	2.33	1.79
BSMD2920-500	7.55	6.70	5.85	5.00	4.20	3.77	3.32	2.92	2.23
BSMD2920-600	8.60	7.70	6.80	6.00	4.95	4.60	4.06	3.65	3.15
BSMD2920-700	10.03	8.98	7.93	7.00	5.77	5.36	4.73	4.26	3.68

➤ Environmental Specifications

Test	Conditions	Resistance change
Passive aging	+85°C, 1000 hours	±5% typical
Humidity aging	+85°C, 85% R.H. , 168 hours	±5% typical
Thermal shock	+85°C to -40°C, 20 times	±33% typical
Resistance to solvent	MIL-STD-202,Method 215	No change
Vibration	MIL-STD-202,Method 201	No change
Ambient operating conditions : - 40 °C to +85 °C		
Maximum surface temperature of the device in the tripped state is 125 °C		

➤ **Soldering Parameters**

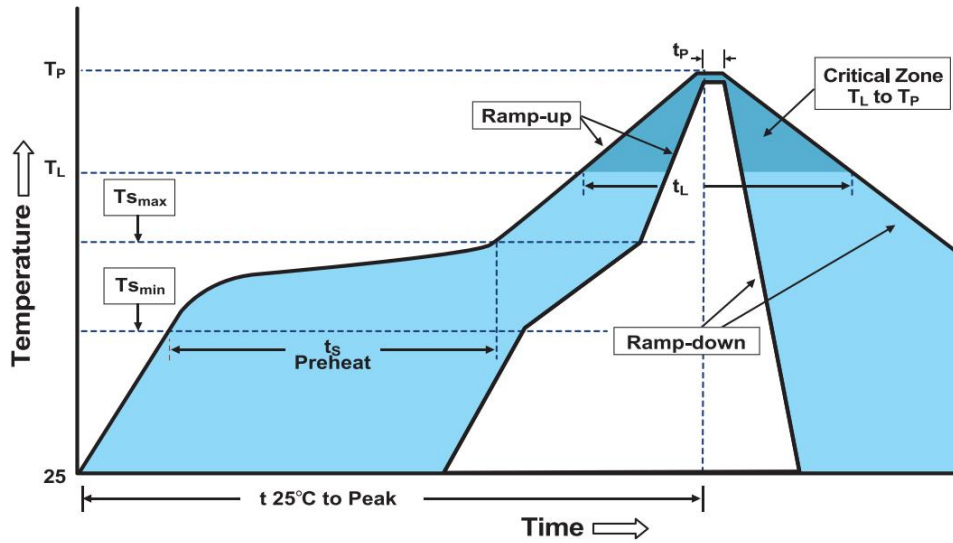

Profile Feature	Pb-Free Assembly
Average Ramp-Up Rate($T_{s_{max}}$ to T_p)	3°C/second max
Preheat -Temperature Min($T_{s_{min}}$) -Temperature Max($T_{s_{max}}$) -Time($T_{s_{min}}$ to $T_{s_{max}}$)	150°C 200°C 60~180 seconds
Time maintained above: -Temperature(T_L) -Time(t_L)	217°C 60~150 seconds
Peak Temperature(T_p)	260°C
Ramp-Down Rate	6°C/second max
Time 25°C to Peak Temperature	8 minutes max
Storage Condition	0°C~30°C,30%-60%RH

- Recommended reflow methods: IR, vapor phase oven, hot air oven, N₂ environment for lead-free.
- Recommended maximum paste thickness is 0.25mm.
- Devices can be cleaned using standard industry methods and solvents.

Note 1: All temperature refer to topside of the package, measured on the package body surface.

Note 2: If reflow temperatures exceed the recommended profile, devices may not meet the performance requirements.

➤ **Physical Dimensions & Recommended Pad Layout (mm)**

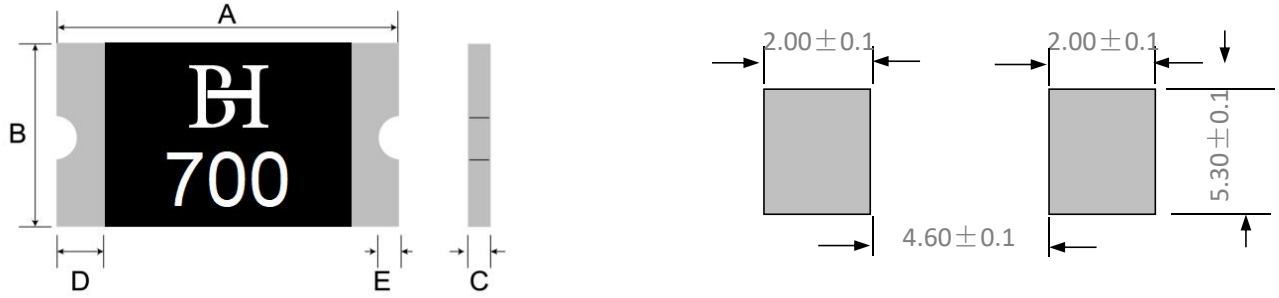

Part Number	Marking	Quantity	A		B		C		D	E
			Min	Max	Min	Max	Min	Max	Min	Min
BSMD2920-020-100V	BH 020	1500	6.73	7.98	4.80	5.44	0.60	1.20	0.30	0.20
BSMD2920-030-60V	BH 030	1500	6.73	7.98	4.80	5.44	0.60	1.20	0.30	0.20
BSMD2920-050-60V	BH 050	1500	6.73	7.98	4.80	5.44	0.60	1.20	0.30	0.20
BSMD2920-075-33V	BH 075	1500	6.73	7.98	4.80	5.44	0.40	1.40	0.30	0.20
BSMD2920-075-60V	BH 075	1500	6.73	7.98	4.80	5.44	0.60	1.40	0.30	0.20
BSMD2920-100-33V	BH 100	1500	6.73	7.98	4.80	5.44	0.40	1.00	0.30	0.20
BSMD2920-100-60V	BH 100	1000	6.73	7.98	4.80	5.44	1.00	2.10	0.30	0.20
BSMD2920-100-72V	BH 100	1000	6.73	7.98	4.80	5.44	1.00	2.10	0.30	0.20
BSMD2920-125-33V	BH 125	1500	6.73	7.98	4.80	5.44	0.40	1.00	0.30	0.20
BSMD2920-150-33V	BH 150	1500	6.73	7.98	4.80	5.44	0.50	1.30	0.30	0.20
BSMD2920-150-48V	BH 150	1500	6.73	7.98	4.80	5.44	1.00	2.10	0.30	0.20
BSMD2920-150-60V	BH 150	1000	6.73	7.98	4.80	5.44	1.00	2.10	0.30	0.20
BSMD2920-185-33V	BH 185	1500	6.73	7.98	4.80	5.44	0.40	1.40	0.30	0.20
BSMD2920-200-16V	BH 200	1500	6.73	7.98	4.80	5.44	0.40	1.40	0.30	0.20
BSMD2920-200-24V	BH 200	1500	6.73	7.98	4.80	5.44	0.40	1.40	0.30	0.20
BSMD2920-200-30V	BH 200	1500	6.73	7.98	4.80	5.44	0.40	1.40	0.30	0.20
BSMD2920-200-33V	BH 200	1500	6.73	7.98	4.80	5.44	0.40	1.40	0.30	0.20
BSMD2920-200-36V	BH 200	1500	6.73	7.98	4.80	5.44	0.40	1.40	0.30	0.20
BSMD2920-200-48V	BH 200	1500	6.73	7.98	4.80	5.44	0.40	1.40	0.30	0.20
BSMD2920-200-60V	BH 200	1000	6.73	7.98	4.80	5.44	0.80	2.00	0.30	0.20
BSMD2920-250-16V	BH 250	1500	6.73	7.98	4.80	5.44	0.40	1.40	0.30	0.20
BSMD2920-250-24V	BH 250	1500	6.73	7.98	4.80	5.44	0.40	1.40	0.30	0.20
BSMD2920-250-30V	BH 250	1500	6.73	7.98	4.80	5.44	0.40	1.40	0.30	0.20
BSMD2920-250-33V	BH 250	1500	6.73	7.98	4.80	5.44	0.40	1.40	0.30	0.20

Part Number	Marking	Quantity	A		B		C		D	E
			Min	Max	Min	Max	Min	Max	Min	Min
BSMD2920-260-6V	BI 260	1500	6.73	7.98	4.80	5.44	0.40	1.40	0.30	0.20
BSMD2920-260-16V	BI 260	1500	6.73	7.98	4.80	5.44	0.40	1.40	0.30	0.20
BSMD2920-260-24V	BI 260	1500	6.73	7.98	4.80	5.44	0.40	1.40	0.30	0.20
BSMD2920-300-6V	BI 300	1500	6.73	7.98	4.80	5.44	0.40	1.40	0.30	0.20
BSMD2920-300-16V	BI 300	1500	6.73	7.98	4.80	5.44	0.40	1.40	0.30	0.20
BSMD2920-300-24V	BI 300	1500	6.73	7.98	4.80	5.44	0.40	1.60	0.30	0.20
BSMD2920-300-30V	BI 300	1500	6.73	7.98	4.80	5.44	0.40	1.60	0.30	0.20
BSMD2920-300-33V	BI 300	1500	6.73	7.98	4.80	5.44	0.40	1.60	0.30	0.20
BSMD2920-300-36V	BI 300	1500	6.73	7.98	4.80	5.44	0.40	1.60	0.30	0.20
BSMD2920-330-16V	BI 330	1500	6.73	7.98	4.80	5.44	0.40	1.60	0.30	0.20
BSMD2920-330-24V	BI 330	1500	6.73	7.98	4.80	5.44	0.40	1.60	0.30	0.20
BSMD2920-330-30V	BI 330	1500	6.73	7.98	4.80	5.44	0.40	1.60	0.30	0.20
BSMD2920-330-33V	BI 330	1500	6.73	7.98	4.80	5.44	0.40	1.60	0.30	0.20
BSMD2920-400-6V	BI 400	1500	6.73	7.98	4.80	5.44	0.40	1.60	0.30	0.20
BSMD2920-400-12V	BI 400	1500	6.73	7.98	4.80	5.44	0.40	1.60	0.30	0.20
BSMD2920-400-16V	BI 400	1500	6.73	7.98	4.80	5.44	0.40	1.60	0.30	0.20
BSMD2920-400-24V	BI 400	1500	6.73	7.98	4.80	5.44	0.40	1.60	0.30	0.20
BSMD2920-400-30V	BI 400	1500	6.73	7.98	4.80	5.44	0.40	1.60	0.30	0.20
BSMD2920-500-6V	BI 500	1500	6.73	7.98	4.80	5.44	0.50	1.60	0.30	0.20
BSMD2920-500-12V	BI 500	1500	6.73	7.98	4.80	5.44	0.50	1.60	0.30	0.20
BSMD2920-500-16V	BI 500	1500	6.73	7.98	4.80	5.44	0.50	1.60	0.30	0.20
BSMD2920-500-24V	BI 500	1500	6.73	7.98	4.80	5.44	0.50	1.60	0.30	0.20
BSMD2920-500-30V	BI 500	1500	6.73	7.98	4.80	5.44	0.50	1.60	0.30	0.20
BSMD2920-600-6V	BI 600	1500	6.73	7.98	4.80	5.44	0.50	1.60	0.30	0.20
BSMD2920-600-12V	BI 600	1500	6.73	7.98	4.80	5.44	0.50	1.60	0.30	0.20
BSMD2920-600-16V	BI 600	1500	6.73	7.98	4.80	5.44	0.50	1.60	0.30	0.20
BSMD2920-700-6V	BI 700	1500	6.73	7.98	4.80	5.44	0.50	1.60	0.30	0.20
BSMD2920-700-12V	BI 700	1500	6.73	7.98	4.80	5.44	0.50	1.60	0.30	0.20

➤ **Tape And Reel Specifications (mm)**

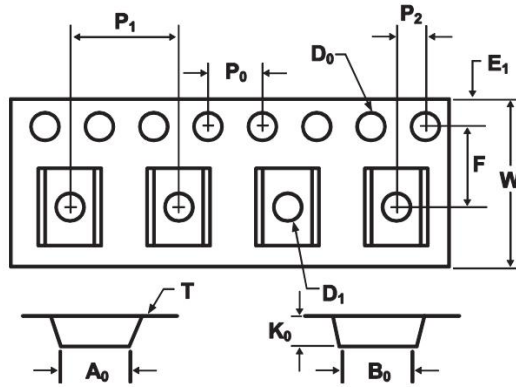

Governing Specifications	BSMD2920-020~ BSMD2920-185	BSMD2920-200~ BSMD2920-700
W	16.0 ± 0.3	16.0 ± 0.3
F	7.5 ± 0.05	7.5 ± 0.05
E ₁	1.75 ± 0.1	1.75 ± 0.1
D ₀	1.55 ± 0.05	1.55 ± 0.05
D ₁	1.55 _{min}	1.55 _{min}
P ₀	4.0 ± 0.1	4.0 ± 0.1
P ₁	8.0 ± 0.1	8.0 ± 0.1
P ₂	2.0 ± 0.05	2.0 ± 0.05
A ₀	5.74 ± 0.1	5.74 ± 0.1
B ₀	8.02 ± 0.1	8.02 ± 0.1
T	0.3 ± 0.1	0.3 ± 0.1
K ₀	1.04 ± 0.1	1.35 ± 0.1
Leader _{min}	390	390
Trailer _{min}	160	160

Reel Dimensions	
C	φ178 ± 1.0
D	φ60.2 ± 0.5
H	16.0 ± 0.5
W	13.2 ± 1.5

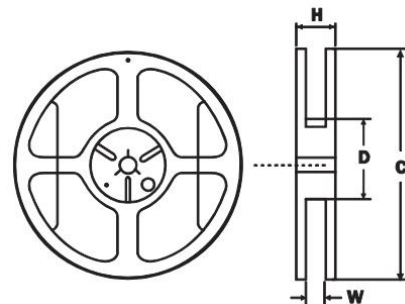

➤ Warning

1. PTC Device is a resettable overcurrent circuit protection device used to protect against overcurrent faults in electronic circuits. It cannot be used as a switch, and multiple times tripping will reduce the PTC hold current. PTC 器件是一种可复位的过电流保护元件，用于保护电子电路中的过流故障，不能作为开关使用，重复多次保护会降低 PTC 的维持电流。
2. The PTC is a thermally sensitive device with a positive temperature coefficient which means that the resistance increases with increasing temperature. It is recommended to keep away from heat source devices when designing to minimize the influence of external heat sources. PTC 是一种具有正温度系数的热敏器件，即电阻随温度升高而增大。设计时建议远离热源器件，尽量减少外部热源的影响。
3. This product should not be used in an application where the maximum voltage or maximum current can be exceeded in a fault condition. Operation beyond the maximum ratings or improper use may result in device damage and possible electrical arcing and flame. 本产品不应用于在故障条件下可能超过最大电压或最大电流的应用中，超出最大额定值的操作或不当使用可能会导致 PTC 损坏，出现电弧现象，甚至烧毁。
4. Hold current at all temperature specified in the specification is the conventional performance of PTC obtained by one reflow soldering. It can hold 1 hour under the current conditions corresponding to different temperatures. This current is not the condition of long-term charging or discharging current for this type of PTC. 规格书中所规定的各温度下的维持电流是 PTC 通过一次回流焊接后获得的常规性能。PTC 在不同温度对应的当前电流条件下可保持 1 小时。该电流并不是该型号 PTC 能够适应的长期充电或放电电流的条件。
5. The resistance and other electrical parameters indicated in the specification are all based on the test results of the manufacturer's designated test board by one reflow soldering. If there is any further heat generated process like multiple soldering, injection molding, dispensing, the product parameters will decrease at certain degree. Therefore the verification test to be conducted is necessary. 规格书中的电阻等电气参数均以厂家指定测试板一次回流焊的测试结果为准。如果有进一步的发热过程，如多次焊接、注塑、点胶等，产品参数会有所衰减，因此需要进行验证测试其适用性。
6. SMD PTC is designed for the SMT process which applies reflow soldering. For reflow soldering, please refer to the recommended curve diagram. If the recommended value is exceeded, the internal resistance of PTC may increase. Hand soldering is not recommended and heat gun is not allowed to use during the circuit boards rework. If there is soldering iron welding process, it is recommended that the welding position should be more than 1.5mm away from PTC, the welding temperature should be lower than 350°C, and the contact time with the solder joint should not exceed 3 seconds. SMD PTC 是为采用回流焊接 SMT 工艺设计的。焊接工艺请参考厂家推荐的回流焊曲线图。如果超过推荐值，PTC 的内阻可能会增加并受到损伤。禁止使用手工焊接，禁止电路板返工时使用热风枪。如果有烙铁焊接工艺，建议焊接位置离 PTC 元件 1.5mm 以上，焊接温度低于 350°C，与焊点接触时间不超过 3 秒。
7. When mounting or using PTC, all injection molding materials, curing adhesives, UV glue, silica gel and cleaning agents or solvents must be tested in terms of application parameters e.g. temperature, time, and etc to ensure the consistency between the product and the processing before use. 贴装或应用 PTC 时，所有注塑材料、固化粘合剂、UV 胶、硅胶和清洁剂或溶剂都必须在应用参数方面进行测试，例如温度、时间等，以保证产品及工艺的匹配性，确认不会影响 PTC 性能之后方可使用。
8. When mounting or using PTC, it is not recommended to use circuit board washer water or other cleaning agent. If cleaning is required, it is necessary to verify the applicability of various cleaning agents, washboard water and solvents, and confirm that they will not affect the PTC performance. The known chemicals that impacts PTC include but not limited to ethers, benzene homolog, ketones, lipids and derivatives that is of strong solubleness and ruinous. Please place the product in open environment for at least 24 hours to volatilize solvents residuals. 贴装或应用 PTC 时，不建议使用电路板清洗水或其他清洁剂。如果需要清洗时，需要验证各种清洗剂、洗板水和溶剂的适用性，并确认它们不会影响 PTC 性能。已知的影响 PTC 的化学药品包括但不限于醚类、苯同系物、酮类、脂类和具有强溶解性和破坏性的有机化合物。清洗后请将产品放置在开放环境中至少 24 小时以充分挥发溶剂残留物。
9. When PTC is welded to the PCB in product application, if injection or gluing is needed, it should be completed in as short a time as possible. If the time slot between mounting and injection or gluing surpasses 1 month, please keep in airtight environment to avoid long air exposure. 产品应用中 PTC 焊接到 PCB 后，如需注胶或胶合，应在尽可能短的时间内完成。如果贴装和注塑或涂胶之间的时间间隔超过 1 个月，请密封保存，避免 PTC 长时间暴露在空气中。
10. In charging terminal application, PP type material is recommended to use as inner membrane and TPE and PVC type material is inhibited. PTC 在充电终端应用中，建议使用 PP 类材料作为内膜，禁止使用 TPE 类和 PVC 类材料。
11. **BHFUSE** SMD PTC humidity sensitivity grade 2, for sealed packaging. If customers find damaged packaging in stock, they should isolate the product immediately. If there is any surplus material, they needs to be restored to the previous packaging state and do sealed storage. **BHFUSE 佰宏** SMD PTC 湿敏度为 2 级且为密封包装。如果客户发现库存中包装损坏，应立即将产品隔离。使用时如有余料，需恢复成之前的包装状态，并且密封保存。