

● General Description

The AGMH614C combines advanced trenchMOSFET technology with a low resistance package to provide extremely low $R_{DS(ON)}$.

This device is ideal for load switch and battery protection applications.

● Features

- Advance high cell density Trench technology
- Low $R_{DS(ON)}$ to minimize conductive loss
- Low Gate Charge for fast switching
- Low Thermal resistance
- 100% Avalanche tested
- 100% DVDS tested

● Application

- MB/VGA Vcore
- SMPS 2nd Synchronous Rectifier
- POL application
- BLDC Motor driver

Product Summary

BVDSS	RDSON	ID
60V	11mΩ	50A

TO-220 Pin Configuration

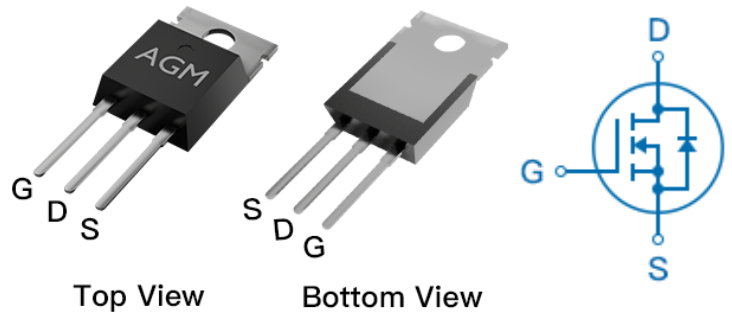

Package Marking and Ordering Information

Device Marking	Device	Device Package	Reel Size	Tape width	Quantity
AGMH614C	AGMH614C	TO-220	---	---	1000

Table 1. Absolute Maximum Ratings (TA=25°C)

Symbol	Parameter	Value	Unit
VDS	Drain-Source Voltage (VGS=0V)	60	V
VGS	Gate-Source Voltage (VDS=0V)	±20	V
ID	Drain Current-Continuous(Tc=25°C) (Note 1)	50	A
	Drain Current-Continuous(Tc=100°C)	33	A
IDM (pluse)	Drain Current-Pulsed (Note 2)	200	A
PD	Maximum Power Dissipation(Tc=25°C)	66	w
	Maximum Power Dissipation(Tc=100°C)	26	w
EAS	Avalanche energy (Note 3)	156	mJ
TJ,TSTG	Operating Junction and Storage Temperature Range	-55 To 150	°C

Table 2. Thermal Characteristic

Symbol	Parameter	Typ	Max	Unit
RθJA	Thermal Resistance Junction-ambient (Steady State) ¹	---	60	°C/W
RθJC	Thermal Resistance Junction-Case ¹	---	1.9	°C/W

Table 3. Electrical Characteristics (T_J=25°C unless otherwise noted)

Symbol	Parameter	Conditions	Min	Typ	Max	Unit
On/Off States						
BVDSS	Drain-Source Breakdown Voltage	VGS=0V ID=250μA	60	--	--	V
IDSS	Zero Gate Voltage Drain Current	VDS=60V,VGS=0V	--	--	1.0	μA
IGSS	Gate-Body Leakage Current	VGS=±20V,VDS=0V	--	--	±100	nA
VGS(th)	Gate Threshold Voltage	VDS=VGS,ID=250μA	2.0	2.8	4.0	V
gFS	Forward Transconductance	VDS=5V,ID=15A	--	18	--	S
RDS(on)	Drain-Source On-State Resistance	VGS=10V, ID=20A	--	11	15	mΩ
Dynamic Characteristics						
Ciss	Input Capacitance	VDS=30V,VGS=0V, F=100 kHz	--	1720	--	pF
Coss	Output Capacitance		--	119	--	pF
Crss	Reverse Transfer Capacitance		--	102	--	pF
Rg	Gate resistance	VGS=0V, VDS=0V,f=1.0MHz	--	1.6	--	Ω
Switching Times						
td(on)	Turn-on Delay Time	VGS=10V,VDS=30V ID=30A,RGEN=1.8Ω	--	14	--	nS
tr	Turn-on Rise Time		--	10	--	nS
td(off)	Turn-Off Delay Time		--	35	--	nS
tf	Turn-Off Fall Time		--	30	--	nS
Qg	Total Gate Charge	VGS=10V, VDS=30V, ID=30A	--	38	--	nC
Qgs	Gate-Source Charge		--	6.0	--	nC
Qgd	Gate-Drain Charge		--	9.0	--	nC
Source-Drain Diode Characteristics						
ISD	Source-Drain Current(Body Diode)		--	--	50	A
VSD	Forward on Voltage	VGS=0V,IS=20A	--	--	1.2	V
trr	Reverse Recovery Time	Is=20A , dI/dt=100A/μs , TJ=25°C	--	38	--	ns
Qrr	Reverse Recovery Charge		--	50	--	nc

Notes 1.The maximum current rating is package limited.

Notes 2.Repetitive Rating: Pulse width limited by maximum junction temperature

Notes 3.EAS condition: T_J=25°C,VDD=30V,Vgs=10V,ID=25A,L=0.5mH,RG=25ohm

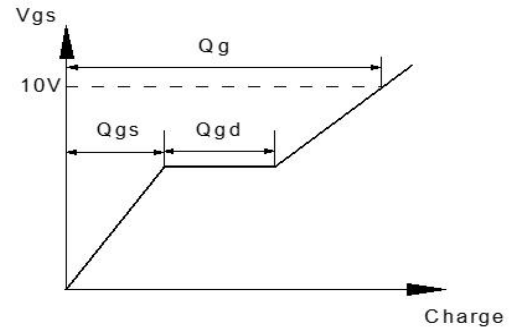
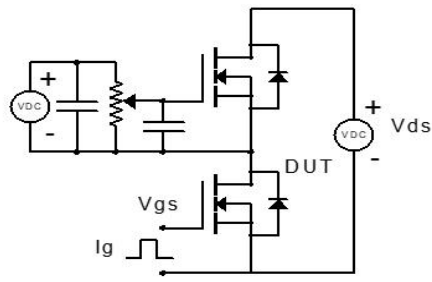

Figure 1: Gate Charge Test Circuit & Waveform

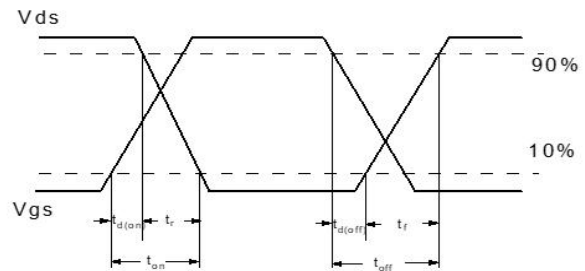
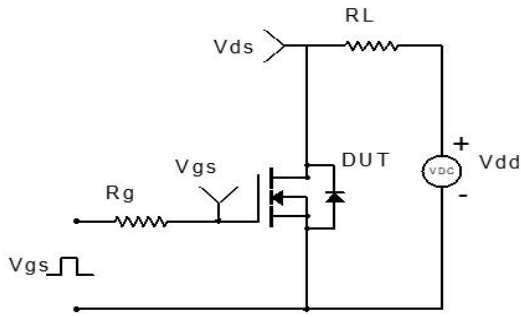

Figure 2: Resistive Switching Test Circuit & Waveform

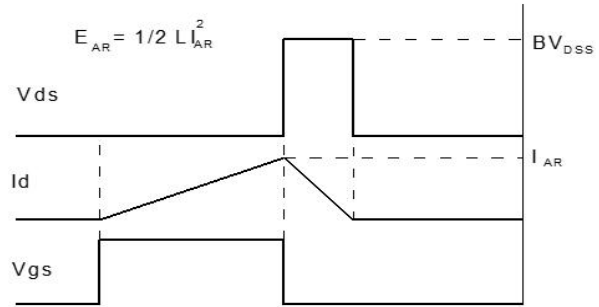
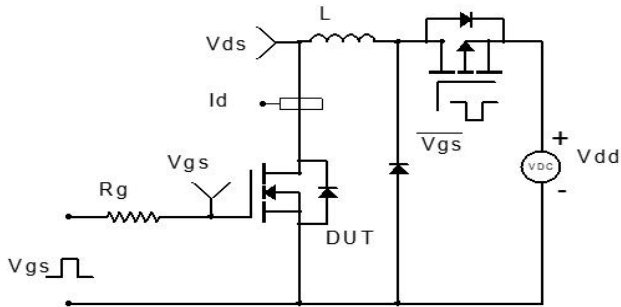

Figure 3: Unclamped Inductive Switching Test Circuit & Waveform

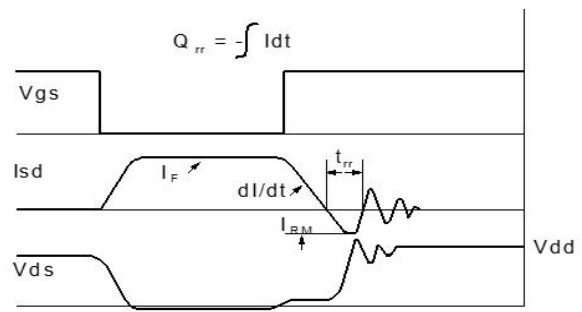
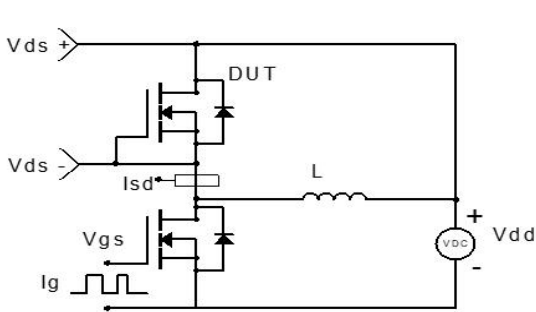
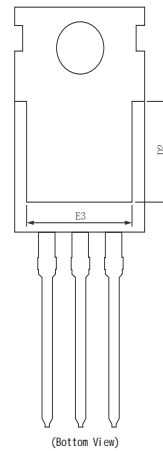
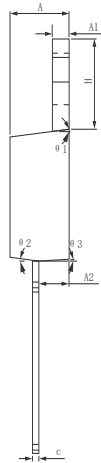
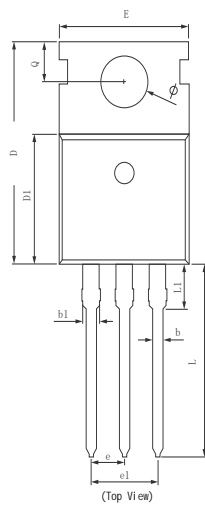
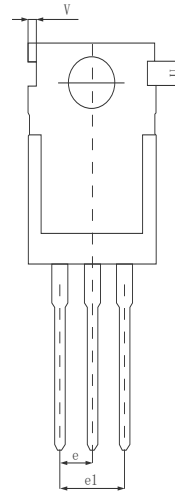
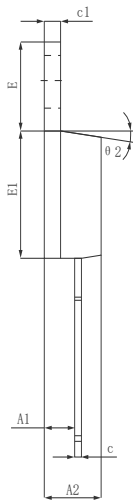
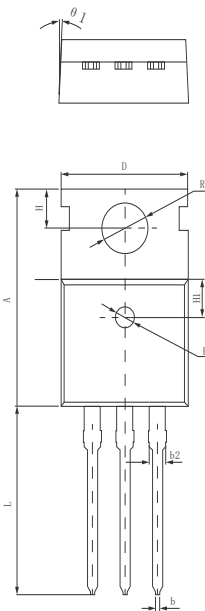

Figure 4: Diode Recovery Test Circuit & Waveform

•Dimensions (TO-220)

SYMBOL	MILLIMETER		
	MIN	Typ.	MAX
A	4.370	4.570	4.700
A1	1.250	1.300	1.400
A2	2.150	2.350	2.550
b	0.700	0.800	0.950
b1	1.170	1.270	1.470
c	0.450	0.500	0.600
D	15.100	15.600	16.100
D1	8.800	9.100	9.400
D2	5.500	6.300 REF	
E	9.700	10.000	10.300
E3	7.000	7.600 REF	
e	2.540 BSC		
e1	5.080 BSC		
L	13.200	13.500	13.800
L1		3.100	3.400
H	6.250	6.500	1.352
Φ	3.400	3.600	3.800
Q	2.600	2.800	3.000
θ 1	7° TYP		
θ 2	7° TYP		
θ 3	3° TYP		



SYMBOL	MILLIMETER		
	MIN	Typ.	MAX
A	15.400	15.600	15.800
A1	2.350	2.400	2.500
A2	4.400	4.500	4.700
b	0.700	0.800	0.900
b2	1.180	1.310	1.440
c	0.480	0.500	0.560
c1	1.290	1.300	1.320
D	9.800	10.000	10.200
E	6.400	6.500	6.600
E1	9.000	9.100	9.200
e	2.420	2.540	2.660
e1	4.840	5.080	5.320
H	2.730	2.800	2.870
H1	2.400	2.500	2.600
L	13.020	13.370	13.720
R	3.500	3.600	3.730
R1	1.400	1.500	1.600
U	1.650	1.750	1.850
V	0.580	0.680	0.780
θ 1	2° 2.5° 3°		
θ 2	6.5° 7° 7.5°		

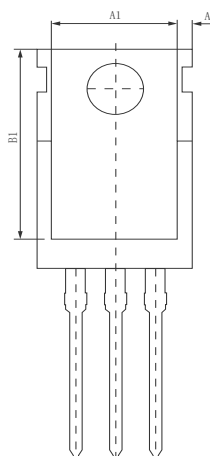
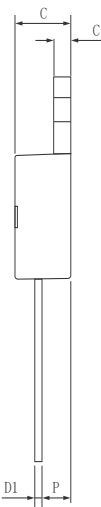
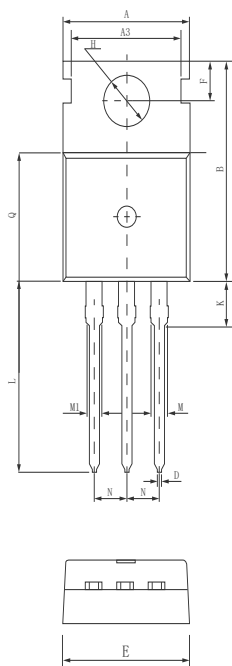

Symbol	Dimensions (mm)
A	10.0±0.3
A1	8.0±0.2
A2	0.94±0.1
A3	8.7±0.1
B	15.6±0.4
B1	13.2±0.2
C	4.5±0.2
C1	1.3±0.2
D	0.8±0.2
D1	0.5±0.1
E	10.0±0.3
F	2.8±0.1
H	3.6±0.1
K	3.1±0.2
L	1.3±0.4
M	1.38±0.1
MI	1.28±0.1
N	2.54 (typ)
P	2.4±0.3
Q	9.15±0.25

TO-220

Marking Instructions:

Model1:

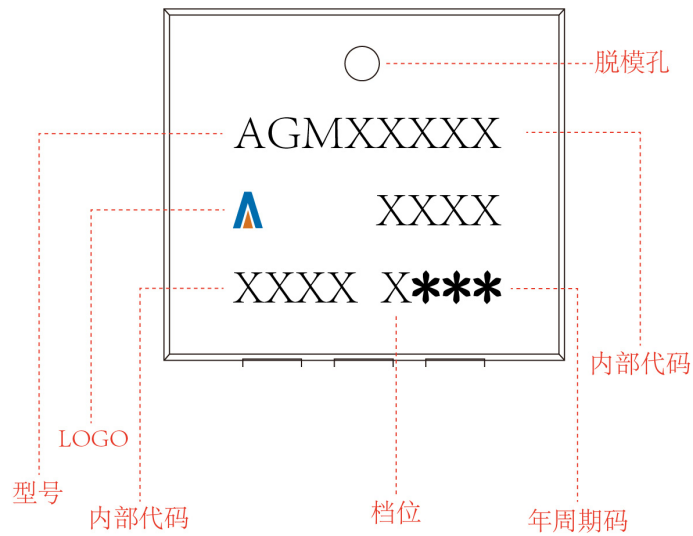

Model2:

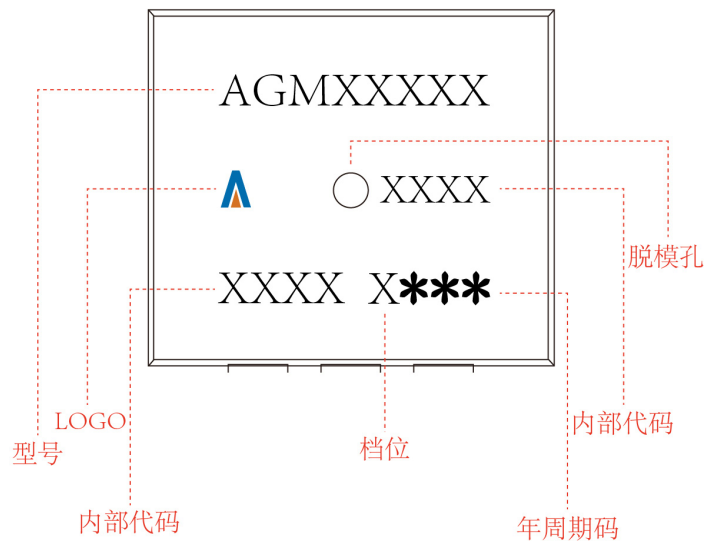

Disclaimer:

The information provided in this document is believed to be accurate and reliable. However, Shenzhen Core Control Source Electronics Technology Co., Ltd. does not assume any responsibility for the following consequences. Do not consider the use of such information or use beyond its scope.

The information mentioned in this document may be changed at any time without notice.

The products and information provided in this document do not infringe patents. Shenzhen Core Control Source Electronics Technology Co., Ltd. assumes no responsibility for any infringement of any other rights of third parties. The result of using such products and information.

This document is the second version issued on April 20th, 2024. This document replaces all previously provided information.

 It is a registered trademark of Shenzhen Core Control Source Electronics Technology Co., Ltd.

Copyright © 2017 Shenzhen Core Control Source Electronics Technology Co., Ltd. all rights reserved.