



MURJ3040CT-MURJ3060CT

30.0 AMP Ultrafast Recovery Rectifier

1. Features

- Adopt FRED chip.
- High frequency operation.
- High current capability.
- High reliability.
- Ultrafast recovery time,high voltage.
- RoHS Compliant.

TO247-3L

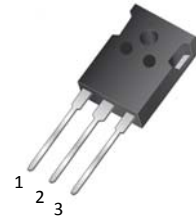

2. Mechanical Data

- Case:Molded Plastic,TO247-3L .
- Epoxy:UL 94V-0 rate flame retardant.
- Terminals:Plated Leads Solderable per MIL-STD-750,Method-2026.
- Marking:marked on body.
- Mounting Position : Any.

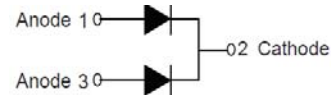

3. Maximum Ratings and Electrical Characteristics

Rating at 25°C ambient temperature unless otherwise specified.

PARAMETER	SYMBOL	MURJ3040CT	MURJ3060CT	UNIT
Maximum Recurrent Peak Reverse Voltage	V_{RRM}	400	600	V
Maximum RMS Voltage	V_{RMS}	280	420	V
Maximum DC Blocking Voltage	V_{DC}	400	600	V
Average Rectified Output Current @Tc=110°C	$I_{F(AV)}$	30.0		A
Peak Forward Surge Current 8.3ms Single half sine-wave superimposed @Tj=25°C on rated load (JEDEC Method)	I_{FSM}	180		A
I ² t Rating for Fusing (t < 8.3ms)	I ² t	134.46		A ² s
Maximum Instantaneous Forward Voltage @I _F =15A	V_{FM}	1.45	1.60	V
Maximum DC reverse current @Tj=25°C at rated DC blocking voltage @Tj=125°C	I_R	10.0 300		uA
Maximum Reverse Recovery Time (Note 1)	T_{RR}	50		ns
Typical Thermal Resistance	$R_{\theta JC}$	1.00		°C/W
Operating Temperature and Storage Temperature Rang	T _j , T _{STG}	-55 to+175		°C



4. Rating And Characteristic Curves

Fig. 1 Forward Current Derating Curve

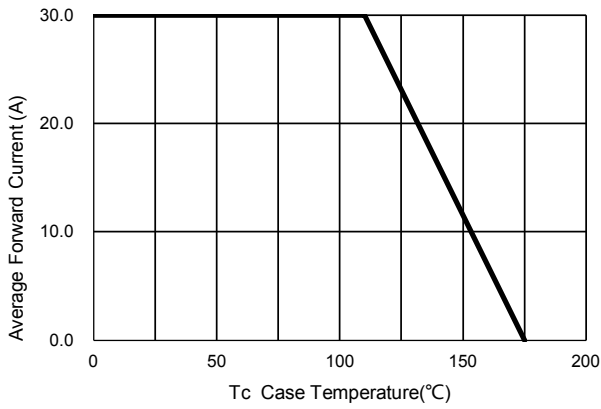

Fig. 2 Typical Forward Characteristics

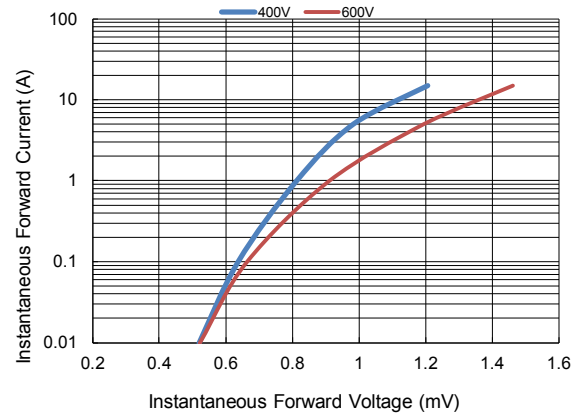

Fig. 3 Forward Surge Current Capability

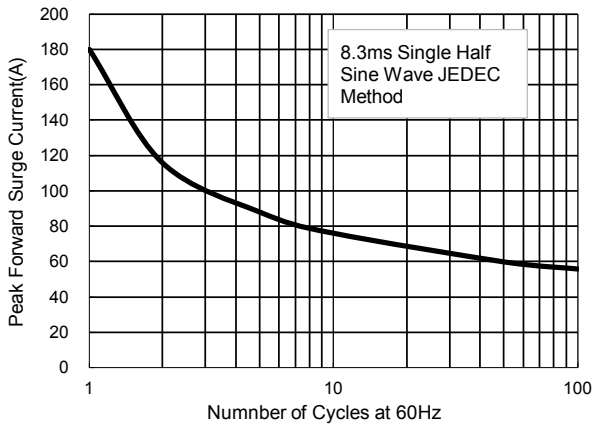
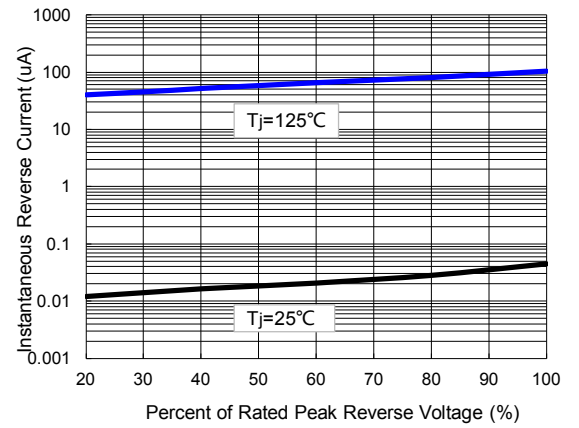

Fig. 4 Typical Reverse Characteristics





MURJ3040CT-MURJ3060CT

30.0 AMP Ultrafast Recovery Rectifier

5. Dimensions

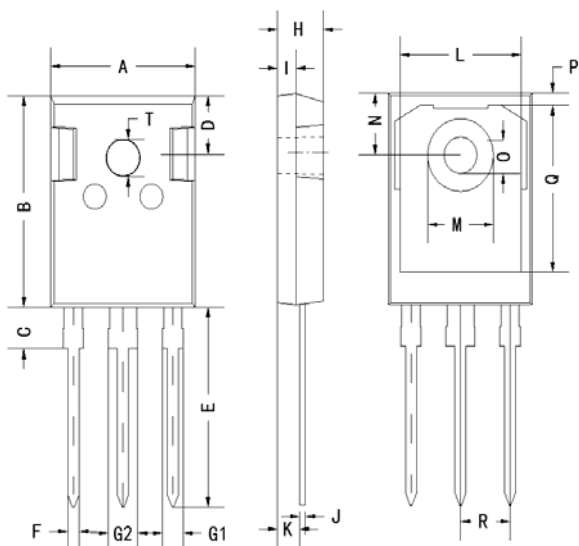

Dimensions	Inches		Millimeters	
	Min	Max	Min	Max
A	0.614	0.630	15.60	16.00
B	0.819	0.835	20.80	21.20
C	0.155	0.170	3.93	4.33
D	0.220	0.236	5.60	6.00
E	0.776	0.792	19.72	20.12
F	0.046	0.050	1.16	1.26
G1		0.089		2.25
G2		0.128		3.25
H	0.193	0.201	4.90	5.10
I	0.075	0.083	1.90	2.10
J	0.021	0.029	0.53	0.725
K	0.091	0.099	2.31	2.51
L	0.516	0.531	13.10	13.50
M	0.276	0.291	7.00	7.40
N	0.238	0.246	6.05	6.25
O	0.14	0.15	3.55	3.75
P	0.04	0.05	1.05	1.35
Q	0.64	0.66	16.25	16.85
R	0.21	0.22	5.34	5.54
T	0.14	0.15	3.65	3.85

6. Part Marking System

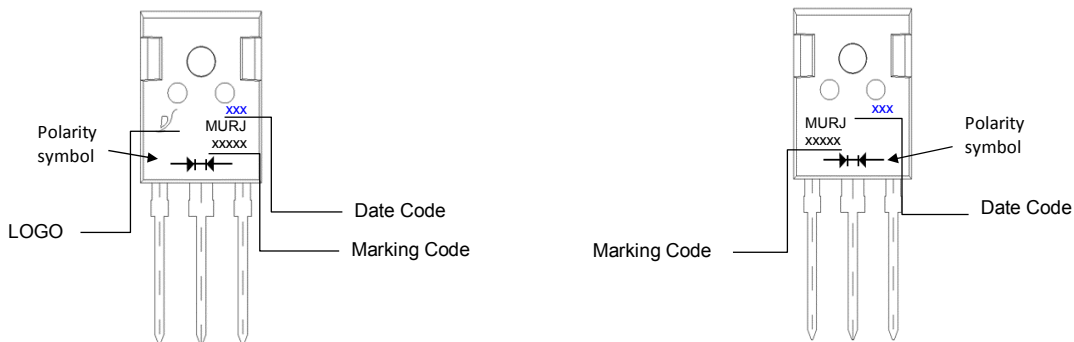

7. Package Information

Package	Packing Type	Tube Size	Quantity(pcs)
		mm	
TO247-3L	Tube	416*45.3*7.5	25



Important Notice and Disclaimer

- Reproducing and modifying information of the document is prohibited without from XINNUO.
- XINNUO reserves the right to make changes to this document and its products and specifications.
- XINNUO disclaims any and all liability arising out of the application or use of any product including damages incidentally and consequentially occurred.
- XINNUO does not assume any and all implied warranties, including warranties of fitness for particular purpose, non-infringement and merchantability.
- Applications shown on the here in document are examples of standard use and operation. Customers are responsible in comprehending the suitable use in particular applications. XINNUO makes no representation or warranty that such applications will be suitable for the specified use without further testing or modification.
- The products shown her are not designed and authorized for equipments requiring high level of reliability or relating to human life and for any applications concerning life-saving or life-sustaining, such as medical instruments, transportation equipment, aerospace machinery et cetera. Customers using or selling these products for use in such applications do so at their own risk and agree to fully indemnify XINNUO for any damages resulting from such improper use or sale.
- Since XINNUO uses lot number as the tracking base, please provide the lot number for tracking when complaining.