

7	8	9
标记 MARK	ECN编号/变更内容 ECN NO/DEFINITION	修改 REVISE
		日期 DATE
		核准 APPROVE

PIN	尺寸 (mm)			
	A	B	C	D
02	0.60	1.36	3.00	2.35
03	1.20	1.96	3.60	2.95
04	1.80	2.56	4.20	3.55
05	2.40	3.16	4.80	4.15
06	3.00	3.76	5.40	4.75
07	3.60	4.36	6.00	5.35
08	4.20	4.96	6.60	5.95
09	4.80	5.56	7.20	6.55
10	5.40	6.16	7.80	7.15

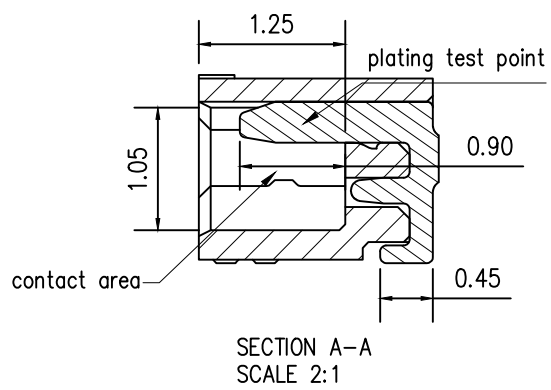
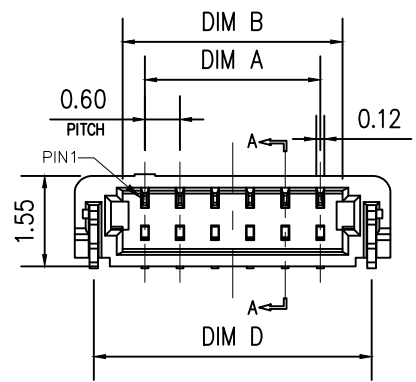
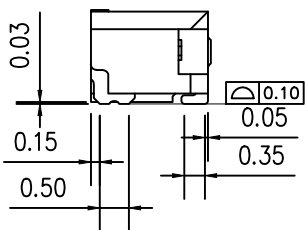
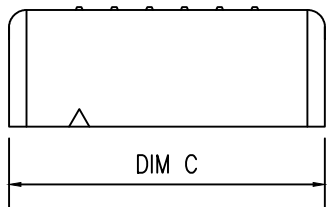

技术要求:

额定电流: 0.2A AC, DC (AWG#36)
 0.3A AC, DC (AWG#34)
 额定电压: 30V (AC, DC)
 温度范围: -25°C ~ +85°C
 接触电阻: 40mΩ max
 绝缘电阻: 100MΩ min
 耐压: 200V AC/min
 绝缘外径: $\phi 0.29 \pm 0.02$ 毫米
 适用导线规格: AWG#36

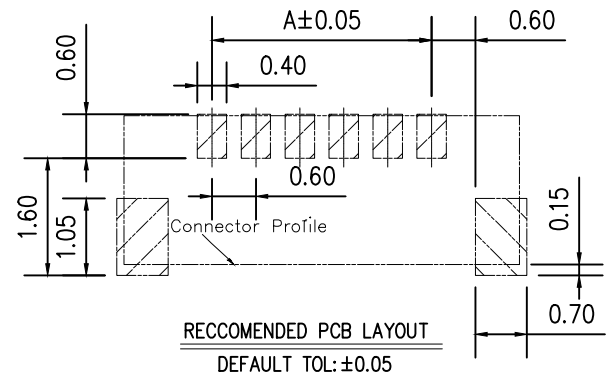
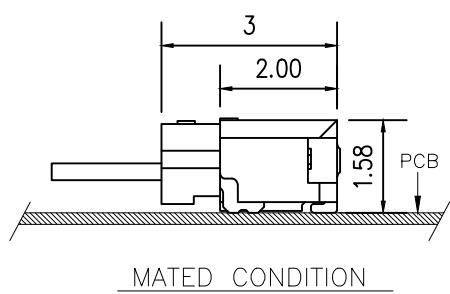

2	接触	铜	镀金	
1	基座	LCP	黑色	
序号	品名	材质	电镀/颜色	备注

	深圳市虹成电子有限公司		品名 TITLE	针座
			料号 PART NO	HC-0.6-7PWT
GENERAL TOLERANCES (UNLESS SPECIFIED)		比列 SCALE	1:1	
X.±0.5	X.±5'	单位 UNIT	MM	
.X±0.3	.X±3'	张数 PART NO	1 OF 1	制图 DRAW
.XX±0.20	.XX±1'	版本 REV	A	审核 CHECKED
				夏操云
				批准 APPROVE
				赵亮亮

