

REV	ECN NO.	LOCAS.	DESCRIPTION	DATE	DESIGN
A			NEW DRAWING		

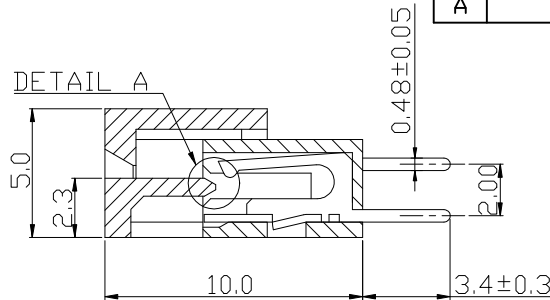

OPEN TYPE

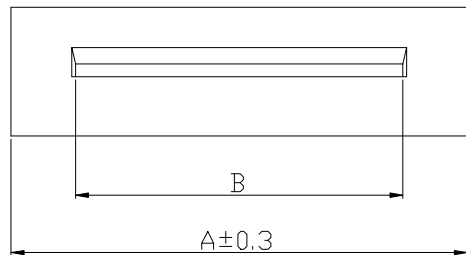
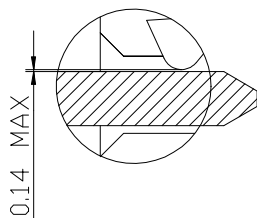
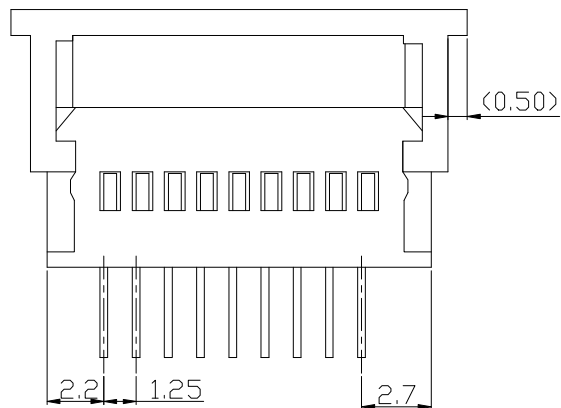

DETAIL A
CLOSE TYPE

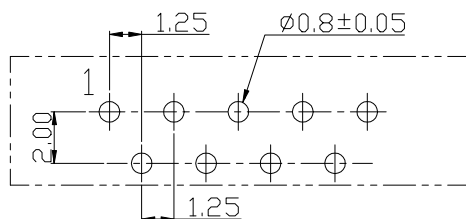

RECOMMEND PCB LAYOUT
COMPONENT SIDE
(FOR GS15-XX0XA)

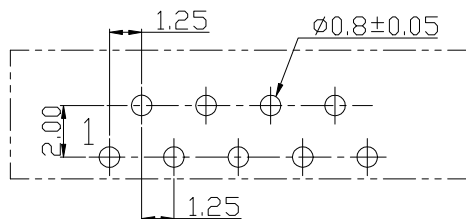

RECOMMEND PCB LAYOUT
COMPONENT SIDE
(FOR GS15-XX0XAW)

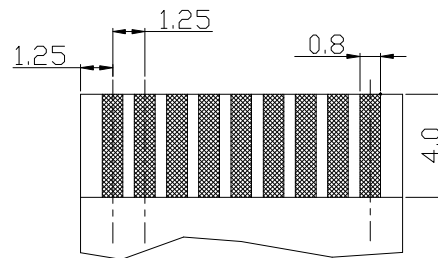

FFC/FPC DIMENSION
THICKNESS 0.3 ± 0.05 mm

NOTES

- MATERIALS:
HOUSING—PBT UL 94V-0
TERMINAL—COPPER ALLOY
- ORDER INFORMATION:
PLATING:
O:Sn 120u" MAX
OVER 50u" MIN NICKEL.
G:LEAD-FREE

CKT	A	B
3	9.55	5.20
4	10.80	6.45
5	12.05	7.70
6	13.30	8.95
7	14.55	10.20
8	15.80	11.45
9	17.05	12.70
10	18.30	13.95
11	19.55	15.20
12	20.80	16.45
13	22.05	17.70
14	23.30	18.95
15	24.55	20.20
16	25.80	21.45
17	27.05	22.70
18	28.30	23.95
19	29.55	25.20
20	30.80	26.45
21	32.05	27.70
22	33.30	28.95
23	34.55	30.20
24	35.80	31.45
25	37.05	32.70
26	38.30	33.95
27	39.55	35.20
28	40.80	36.45
29	42.05	37.70
30	43.30	38.95
31	44.55	40.20
32	45.80	41.45

DESIGN:	Xiping Huang		
CHECK:	Ke Tian		
APPROVED:	Youquan Xu		
DIM	TOL	DIM	TOL
X.	±0.25	X°	±3.0°
X.X	±0.20	X.X°	
X.XX	±0.15	X.XX°	
X.XXX		X.XXX°	

 **广东国连电子有限公司**
GUANGDONG GUOLIAN ELECTRONICS CO., LTD

TITLE: 1.25带锁直插			
PART NO. 1.25-H-NP-***			
REV. A	SCALE: N/A	UNIT: mm	SHEET: 1/1