

Antenna Datasheet

2.4G SMD Chip Antenna

Model:

BW2.4MNX3216

Description:

2.4G SMD Chip Antenna

Features:

2400-2500MHz Frequency Range

360° Omnidirectional Radiation

Dimensions: 3.35mm x 1.75mm x 1.2mm

Compliant with RoHS & REACH Regulations

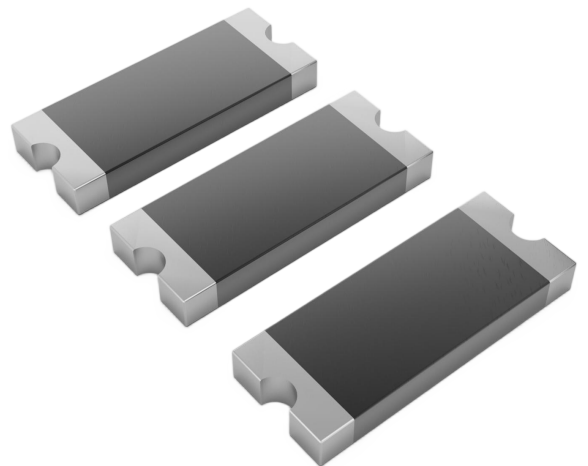

Contents

1.	Description	3
2.	Specifications	4
3.	Dimensions & Drawing & Impedance Matching	5
4.	Evaluation Board Reference	6-7
5.	Testing Equipment	8-9
6.	Performance Data	10
	6.1 VSWR	10
	6.2 Return Loss	10
	6.3 Efficiency and Radiation Patterns	11-12
7.	Reliability and Test Conditions	13
8.	Soldering and Mounting	13
9.	Packaging	14
10.	Antenna Application Precautions	15
11.	Storage and Transportation Information	15



BW2.4MNX3216

Part Number Explanation

BW	Company	Bat Wireless
2.4	Frequency	2400-2500MHz
M	Name	SMD Chip Antenna
N	Type	Internal
X	Content	X
3216	Package Dimensions	3216

1. Description

Bat Wireless **BW2.4MNX3216** is an antenna commonly used in wireless communication. It features high integration for space-saving, with compactness and integration as its key attributes. The patch antenna is directly printed on the SMD, occupying minimal space and making it suitable for compact devices. It offers low cost: utilizing SMD technology for one-time fabrication, it requires no additional antenna components, thus being ideal for mass production. This antenna is suitable for miniaturized devices and widely applied in modules such as IoT, consumer electronics, and industrial equipment.

Classic Application Scenarios:

Consumer Electronics: Remote controls, smart home devices

IoT Devices: Smart meters, trackers

Industrial Equipment: Remote monitoring terminals, vehicle-mounted communication modules

Bat Wireless provides customized services to optimize your equipment. We have a mature R&D team that can respond quickly to meet your needs. If you have any requirements, please contact our sales and FAE.



2. Specification

Parameters	Typ.	Unites	Notes
Electrical Characteristics			
Antenna Type	SMD Chip Antenna		
Frequency Range	2400-2500	MHz	
Input Impedence	50	Ω	
V.S.W.R	<2		
Gain	3.85	dBi	
Polarization Type	Vertical		
Power Capacity	50	W	
Lightning Protection	-		
DC Voltage	-	V	
Radiator	-		
Mechanical Characteristics			
Dimensions	3.35 x 1.75 x 1.2	mm	
Connector Type	-		
Cable Type	-		
Cable Length	-	mm	
Mount way	SMD		
Color	Black		
Meterial	PCB		
Weight	0.2	g	
Environmental Characteristics			
Waterproof Rating	-		
ROHS Compliant	Compliant		
Operating Temperature	-45~ +85	$^{\circ}\text{C}$	
Storage Temperature	-45~ +85	$^{\circ}\text{C}$	

3. Dimensions & Drawing & Impedance Matching

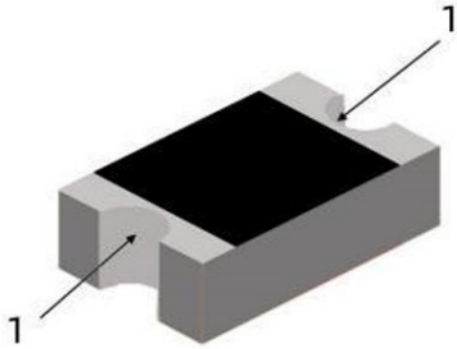

The antenna is symmetric; its feed and ground pads are identical and interchangeable.

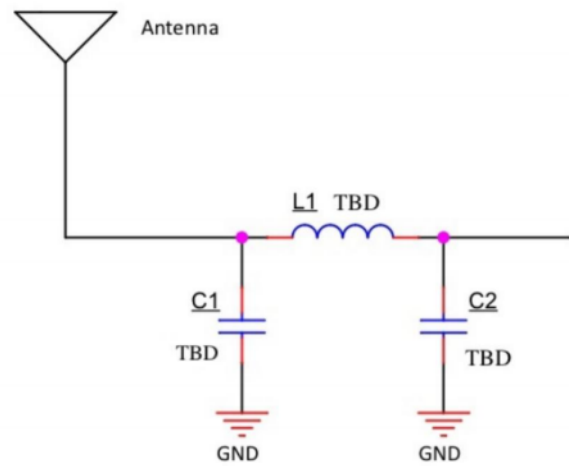

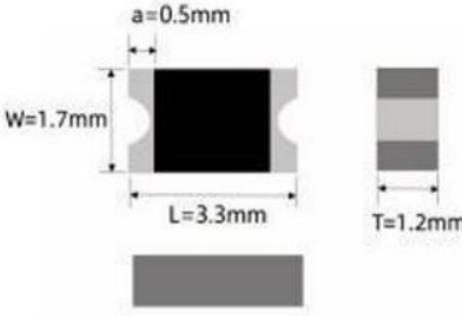
Orthographic Views	Symbol	Dimension (MM)
	L	3.35 ± 0.2
	w	1.75 ± 0.1
	T	1.2 ± 0.1
	a	0.5 ± 0.1

4. Evaluation Board Reference

Antenna Pad and Trace Design

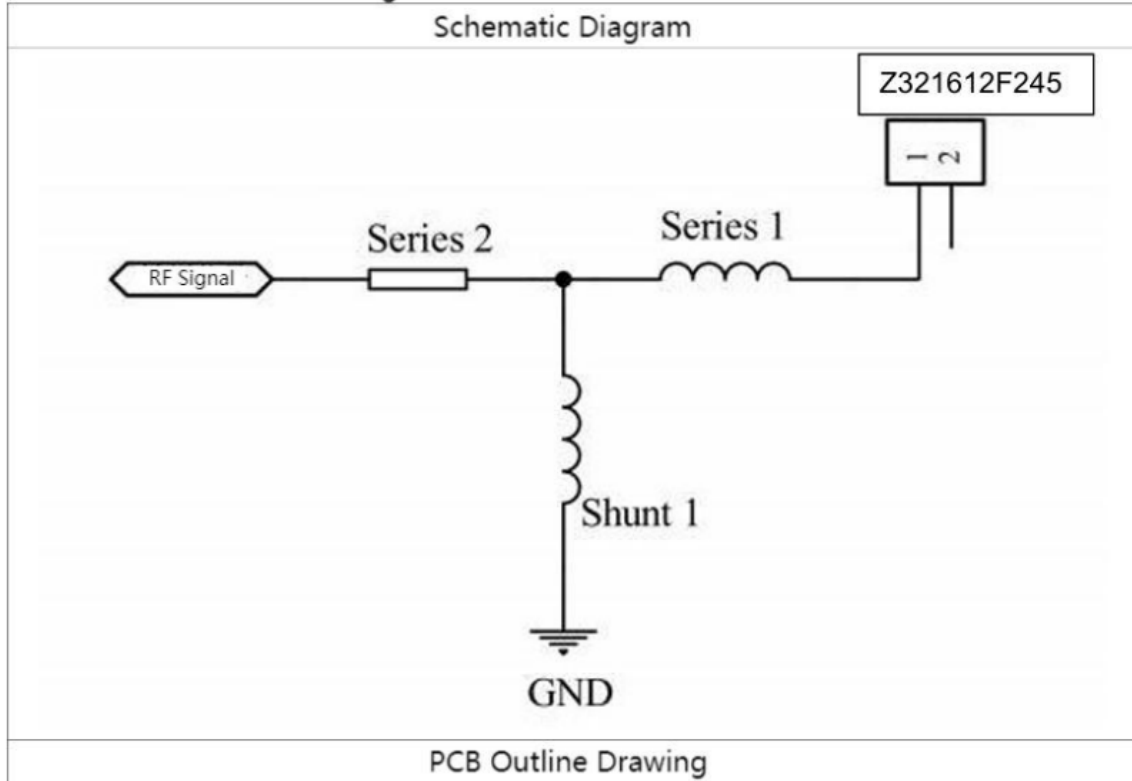

Antenna Testing on a Test Board (Board Thickness: 1.0mm)

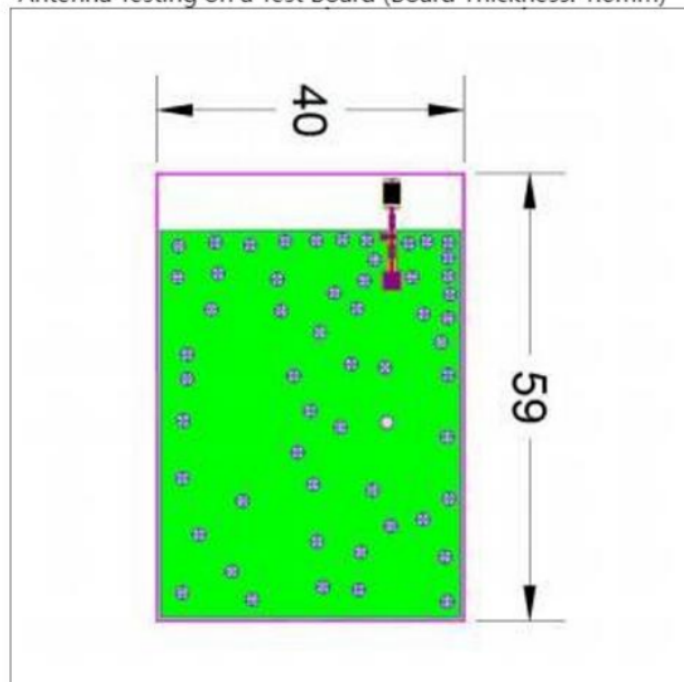

4. Evaluation Board Reference

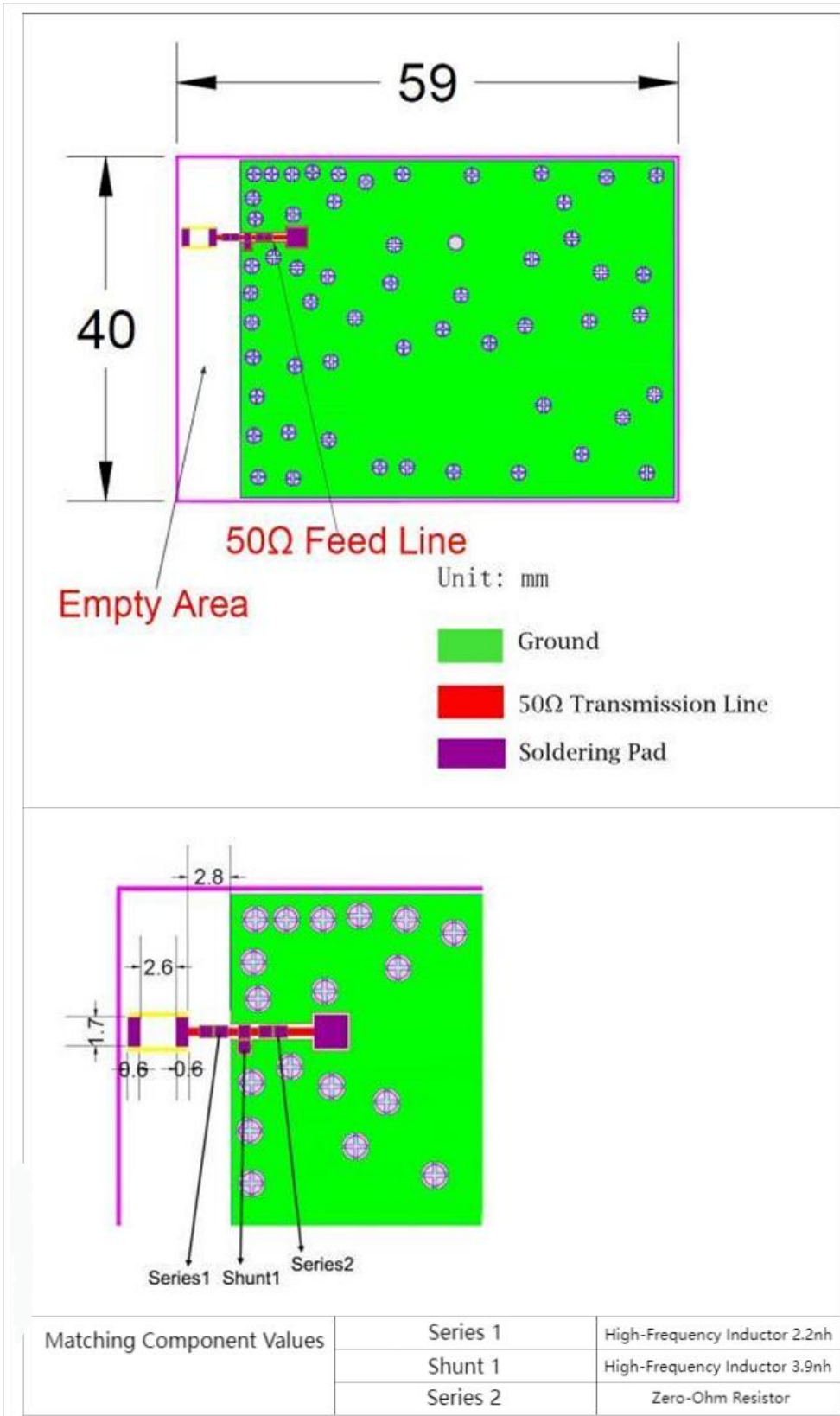

5. Test Equipment



Keysight/E5071C Network Analyzer



R&S/CMW500 Comprehensive Tester



R&S/SMBV100B Signal Generator

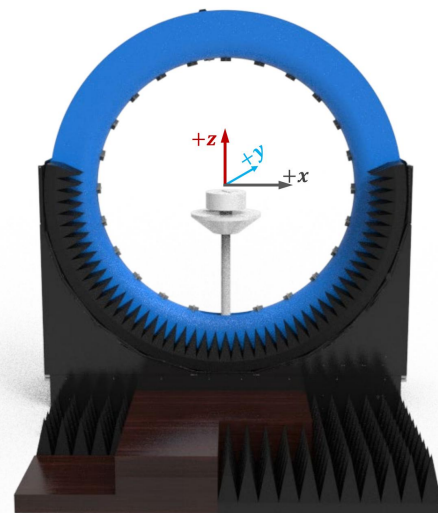

DT-3500 Datasheet

Specification:

Specification:	Description
Test Frequency	400MHz-8.5GHz
System Size	L*W*H=4*3.5*3.5m
Number of Probes	23 (Probe) + 1 (link)
Interval Angle	15°
Sampling Diameter	2200mm
Carring Capacity	≤40kg

Testing Capability

Description

Active measurement

Capability : TRP、TIS、EIRP、EIS,. etc
Mode : 2G/3G/4G/5G、Wi-Fi b/g/n/a/ac/ax、BT、NB-IOT、Cat-M (eMTC)、GPS/BEIDOU/GLONASS、ZigBee、LoRa(Non-Signaling),.etc

Passive measurement

Test category : Gain、Efficiency、2D pattern、3D pattern、Pattern roundness、Axial Ratio、ECC,Phase center,. etc
Polarization : Circular polarization, linear polarization, elliptical polarization

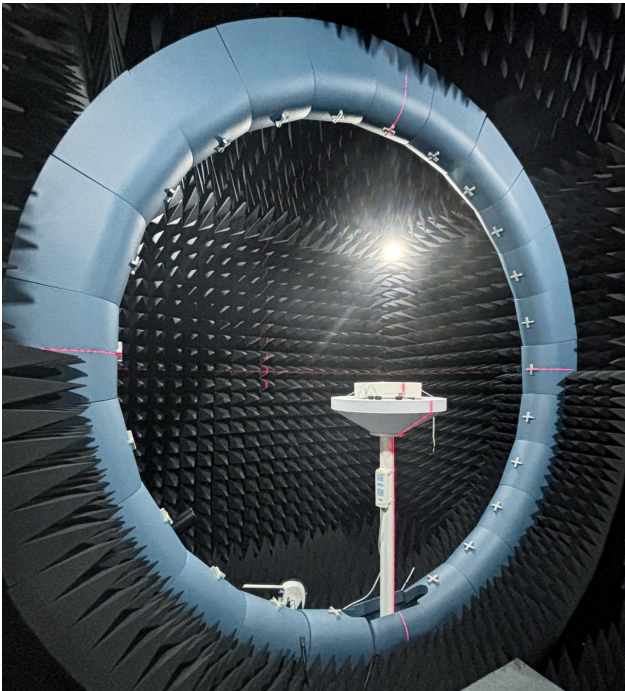

RF Link diaram of multi probe spherical near-field testing system

RF Link Overview

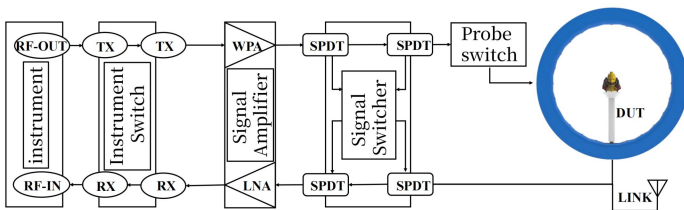

RF Link of Passive measurement

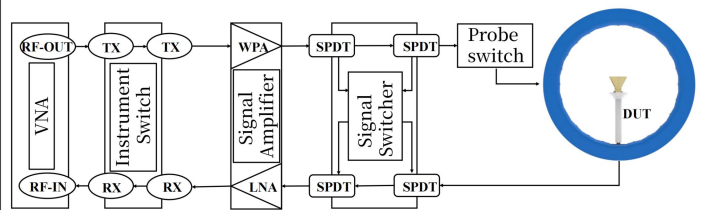

RF Link Overview

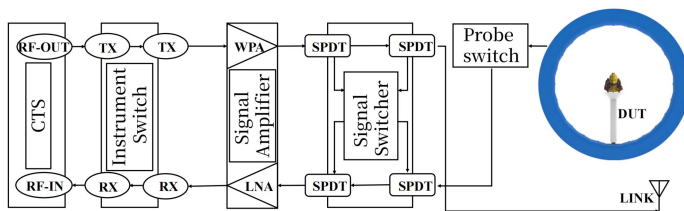

RF Link of Passive measurement

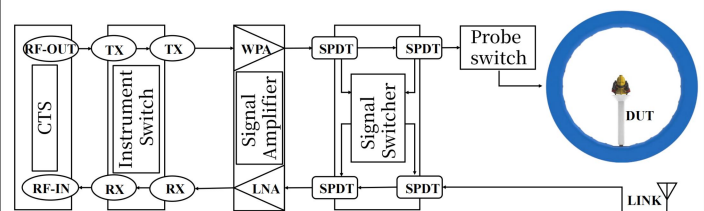

6. Performance Data

6.1 VSWR

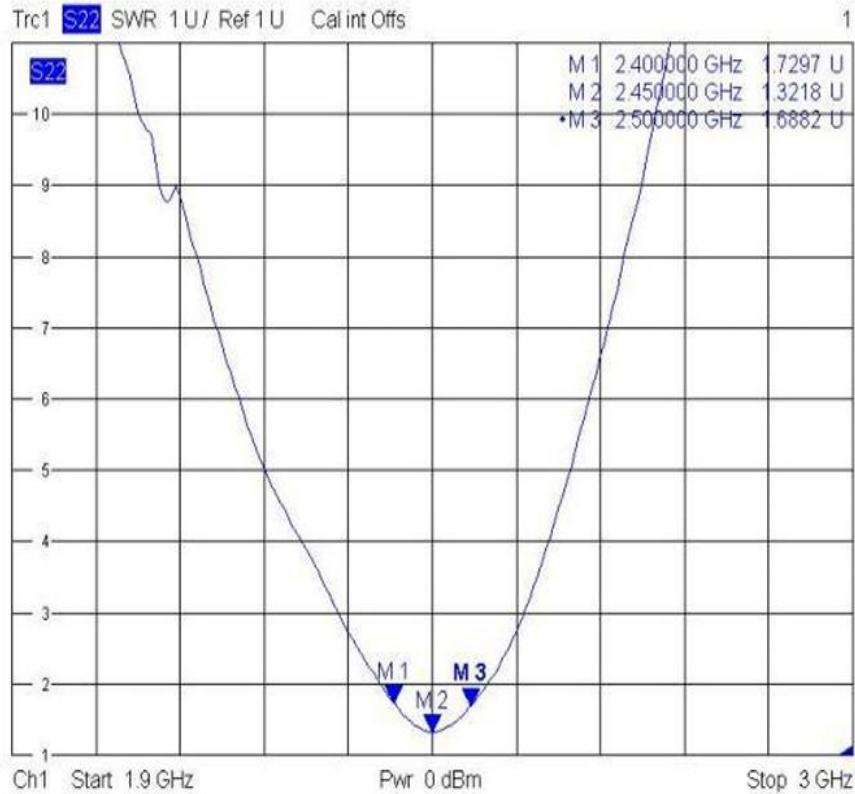

6.2 Return Loss

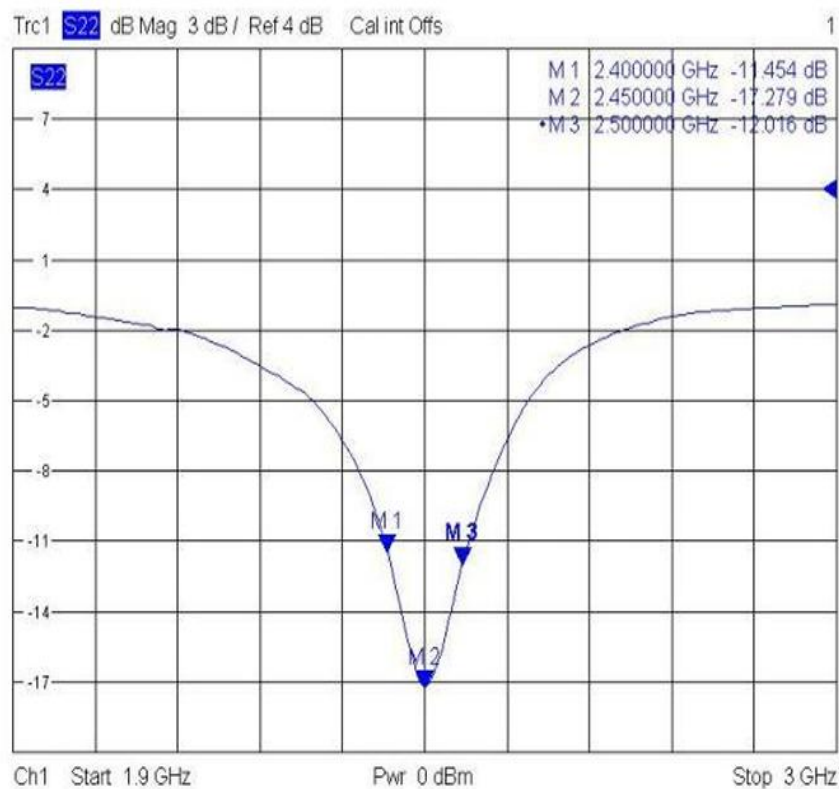

6. Performance Data

6.3 Efficiency and Radiation Patterns

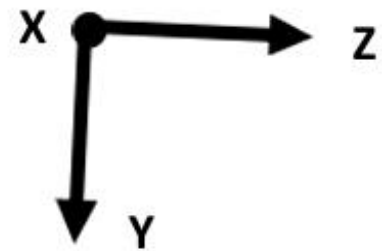
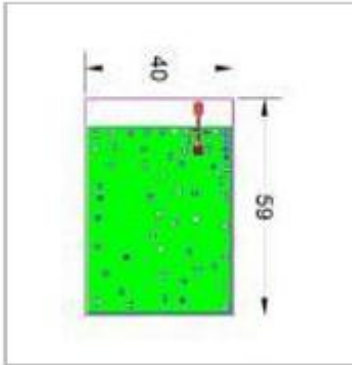

Gain And Efficiency	Bandwidth 2.4G-2.5GHz
Peak Gain	3.85dBi
Average Gain across the band	3.76dBi
Gain Range across the band	3.53dBi~3.85dBi
Peak Efficiency	63.2%
In-Band Average Efficiency	58.8%



Average Efficiency across the band	
Efficiency Range across the band	54.1%~63.2%

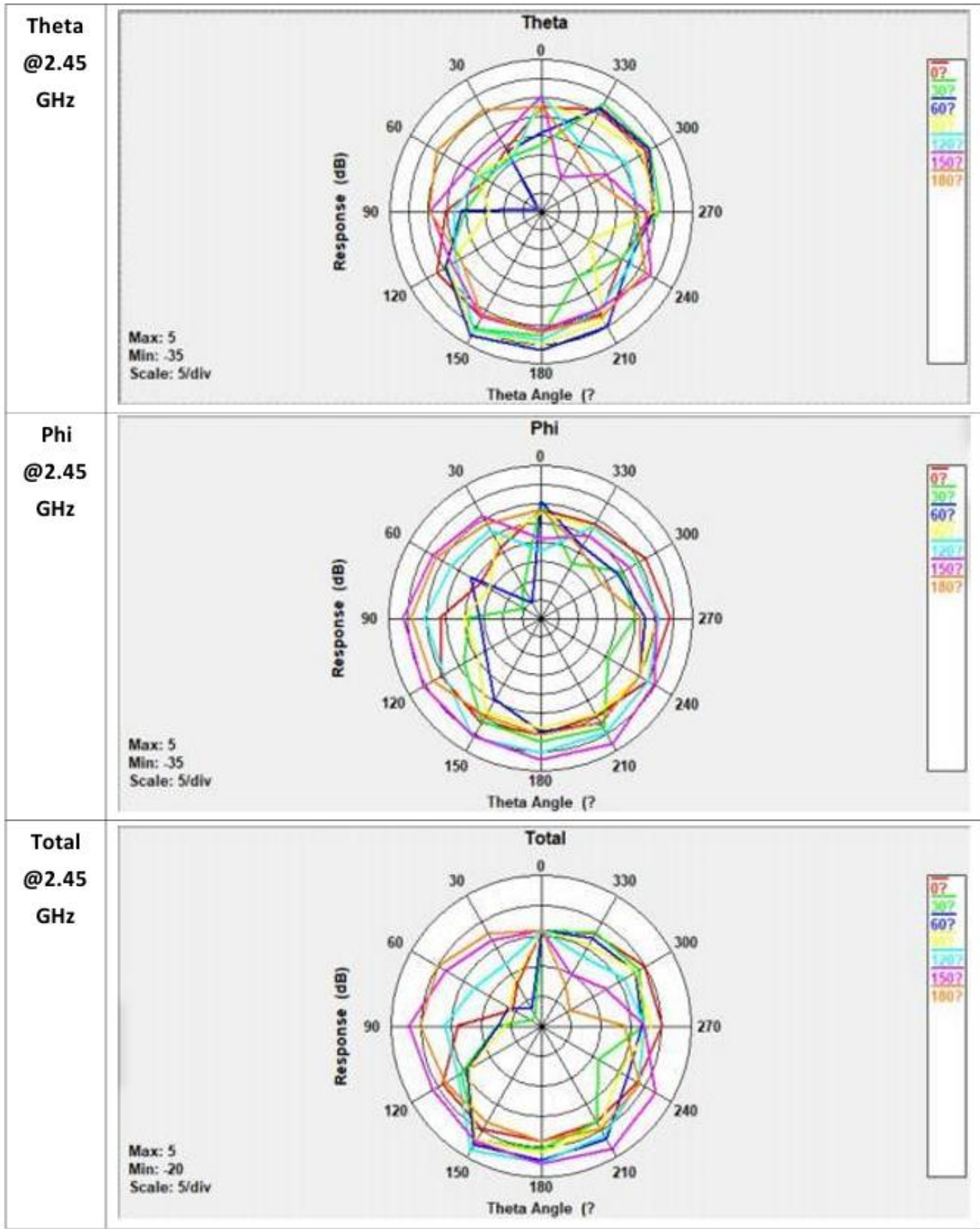

7. Reliability and Test Conditions

Test Item	Test Conditions / Methods	Specifications
Solderability (JIS C 0050-4.6, JESD22-B102D)	<ul style="list-style-type: none"> - Solder bath temperature: $235^{\circ}\text{C} \pm 5^{\circ}\text{C}$ - Immersion time: 2 seconds ± 0.5 seconds - Solder composition: Sn3Ag0.5Cu lead-free solder alloy At least 95% of the surface area of each terminal 	At least 95% of the surface area of each terminal electrode must be covered with fresh solder.
Metallization Layer Corrosion Resistance (IEC 60068-2-58)	<ul style="list-style-type: none"> - Solder bath temperature: 260 ± 5 - Immersion time for metallization corrosion test: 30 seconds ± 0.5 seconds - Solder composition: SN63A 	The loss of the metallization layer in the edge area of each electrode shall not exceed 25% .
Bending Test (JIS C 0051-7.4.1)	<ul style="list-style-type: none"> - Use a pressure bar to apply pressure to the center of the substrate at a rate of 1 mm/s until the substrate deflects by 1 mm. Maintain the pressure for 5 ± 1 seconds after reaching the specified deflection. - After the test, the sample shall be left at room temperature (23 ± 2) for 24 ± 2 hours. 	<ul style="list-style-type: none"> - No mechanical damage. - The electrical specifications shall meet the requirements specified in the electrical characteristics within the operating temperature range of -40°C to 85°C.
Solder Heat Resistance (JIS C 0050-5.4)	<ul style="list-style-type: none"> - Preheating temperature: $120 \sim 150$ - Soldering temperature: 270 ± 5 - Immersion time: 10 ± 1 seconds - Solder: Sn3Ag0.5Cu lead-free - Measure after storing at room temperature for 24 ± 2 hours. 	<ul style="list-style-type: none"> - No mechanical damage. - The electrical specifications shall meet the requirements specified in the electrical characteristics within the operating temperature range of -40 to 85 . - The metallization layer loss at the edge of each electrode shall not exceed 25%.

8. Soldering and Mounting

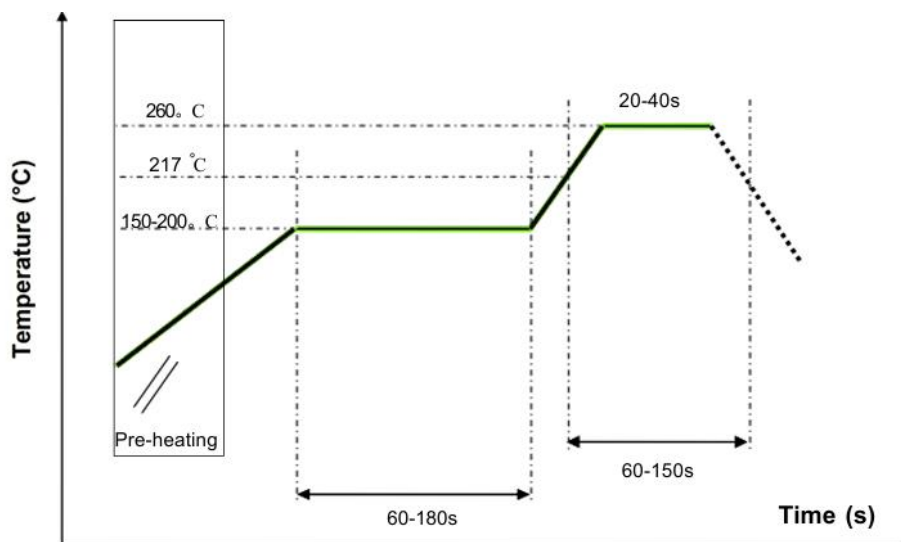



9 . Packaging

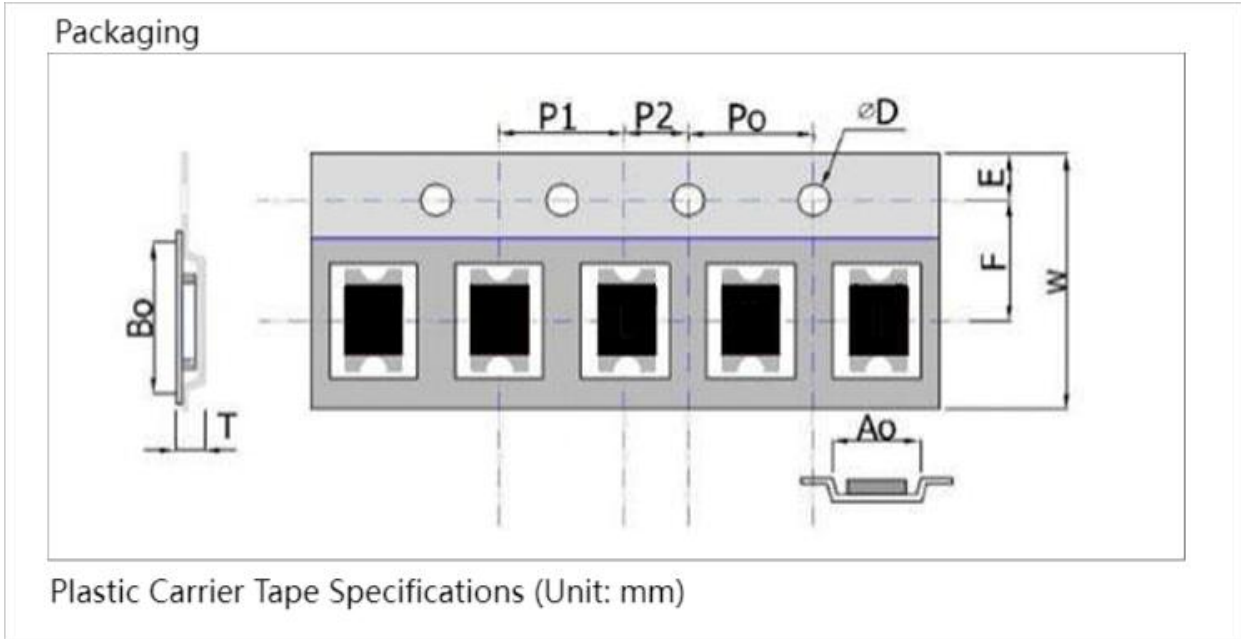

Index	Ao	Bo	ΦD	T	W
Dimension (mm)	2.0±0.1	4.0±0.1	1.55±0.05	1.8±0.1	12±0.1
Index	E	F	Po	P1	P2
Dimension (mm)	1.5±0.1	5.4±0.1	4.0±0.1	4.0±0.1	2.0±0.1

Reel size

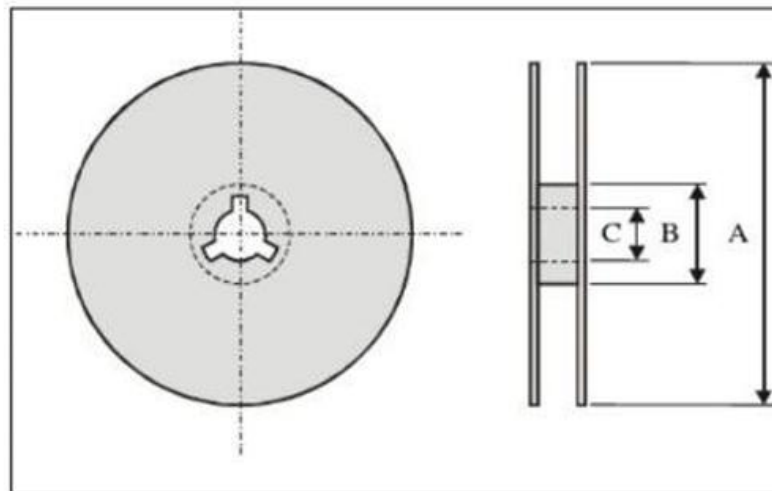

Index	A	B	C
Dimension(mm)	178	60	13.5

Standard quantity: 2500 PCS/plate.



10. Antenna Application Precautions

1. If space permits, it is advisable not to choose antennas with too small dimensions.
2. It is best to have a large clearance area between the antenna and nearby objects; otherwise, matching adjustment will become difficult, and the radiation pattern will be severely distorted.
3. There should be no circuit layout or ground plane beneath the antenna.
4. The antenna should not be placed too close to metal objects, such as batteries and chips, and should not overlap with metal objects like batteries.
5. Note that internal cables (such as battery power cables) should preferably not be too close to the antenna.
6. A monopole antenna requires a reasonable ground plane to achieve optimal performance.
7. Performing antenna matching on the final product solution can shorten the adjustment cycle; whereas on a bare board, repeated adjustments are often needed.
8. Without matching, the same antenna placed on completely different layout boards may not work properly.
9. Do not use a metal housing or a plastic housing with metal covering around the antenna.
10. Do not use very thin antenna feeder wires; the feeder should have a certain width, not less than 0.1mm.
11. Calculate the feeder impedance based on the thickness and dielectric constant of the PCB; 50 ohms will make antenna adjustment easier.
12. Chip antennas should be assembled as far as possible from batteries, EMI shielding materials, foldable speakers, metal nails, LCD screens, etc.

11. Storage and Transportation Information

Storage Conditions

To ensure the solderability of terminal electrodes:

Temperature and humidity requirements: -10~40°C, relative humidity 30~70%.

Recommended service life: Use up within 6 months from the date of delivery.

Packaging storage environment: Should be placed in an air environment free of chlorine and sulfur. Transportation Conditions Handle with care to avoid product damage caused by collision or contamination from sweat, skin oils, etc.

Transportation Conditions

Handle with care to avoid product damage caused by collision or contamination from sweat, skin oils, etc.

Handling Recommendations: It is strongly recommended to use tweezers or a vacuum pen to pick up individual components.

Requirements for bulk handling: Friction and mechanical impact should be minimized.



DECLARATION:

Legal Notice: In order to provide users with better service, Shenzhen Bat Wireless Technology Co., Ltd. (hereinafter referred to as ' Bat Wireless') will endeavour to present users with detailed and accurate product information in this manual. However, due to the time-sensitive nature of the content in this manual, Bat Wireless cannot guarantee the timeliness and applicability of this document at all times. Bat Wireless reserves the right to update the content of this manual without prior notice. To obtain the latest information, we kindly request users to regularly visit the Bat Wireless official website or contact Bat Wireless staff. Thank you for your understanding and support!

Copyright Notice: All content in this product manual (including text, charts, logos, and designs) is protected by copyright law and international copyright treaties. No entity or individual may reproduce, modify, distribute, or use any part or all of this manual in any form (including electronic, mechanical, photocopying, etc.) without prior written authorisation from our company. Infringers will be held legally liable. All rights reserved.

Trademark Notice: All product names and corporate logos of Bat Wireless mentioned in this manual are the lawful property of our company (including affiliated companies). Unauthorised use, reproduction, or imitation is strictly prohibited. Third-party trademarks referenced in this manual are the property of their respective owners, and their use is solely for illustrative purposes and does not imply any commercial affiliation or authorisation. Our company reserves all rights to pursue legal action against any infringement.

Disclaimer: The product information contained in this manual is for reference only. Actual product performance may vary depending on the usage environment and configuration differences. Our company makes no express or implied warranties regarding the accuracy, completeness, or applicability of the content of this manual and shall not be liable for any direct or indirect losses arising from the use or inability to use the content of this manual. Users should assess the applicability of the product and follow actual operating procedures. The final interpretation of this manual is reserved by our company.

Shenzhen Bat Wireless Technology Co.,Ltd

Office Add: Room 1301, 13th Floor, No. 8 Langhua Road, Xinshi Community, Dalang Street, Longhua District, Shenzhen

Email: marketing@batwireless.com

Tel: 0755-21031236



Documentation

Version :	August-21-2025-A01
Date :	2025-8-21
Remarks :	First update
Author:	Carly

Change Log
