

# ACNT-H511

## Open-Collector Output Optocoupler in 15-mm Stretched SO8 Package

### Overview

The ACNT-H511 is a single-channel open-collector output optocoupler in Stretched SO8 footprint. It uses an insulating layer between the light emitting diode and an integrated photon detector to provide electrical insulation between input and output. Separate connections for the photodiode bias and output transistor collector increase the speed up to a hundred times over that of a conventional photo-transistor coupler by reducing the base-collector capacitance.

The ACNT-H511 with 15-mm creepage/clearance and high-voltage insulation capability is suitable for isolated communication logic interface and control in high-voltage power systems such as 690VAC drives, renewable inverters, and medical equipment.

### Functional Diagram

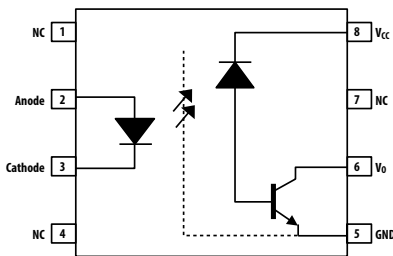

### Truth Table

LED	Output
ON	L
OFF	H

A 0.1- $\mu$ F bypass capacitor must be connected between pins  $V_{CC}$  and GND.

### Features

- TTL compatible
- Package: 15-mm stretched SO8 package
- Open-Collector Output
- 40 kV/ $\mu$ s typical common-mode rejection at  $V_{CM} = 1500V$
- Guaranteed performance within temperature range:  $-40^{\circ}C$  to  $+105^{\circ}C$
- Worldwide safety approval:
  - UL1577 recognized: 7500V<sub>RMS</sub> for 1 minute
  - CSA approval
  - IEC 60747-5-5 approval for reinforced insulation

### Applications

- High-voltage power systems, for example, 690V AC drives
- Renewable energy inverters
- Feedback elements in switching power supplies
- Digital isolation for A/D, D/A conversion digital field
- Communications interface
- MCU interface

**CAUTION!** It is advised that normal static precautions be taken in handling and assembly of this component to prevent damage and/or degradation that may be induced by ESD. The components featured in this data sheet are not to be used in military or aerospace applications or environments.

# Ordering Information

ACNT-H511 is UL Recognized with 7500V<sub>rms</sub> for 1 minute per UL1577.

Part Number	Option RoHS Compliant	Package	Surface Mount	Tape and Reel	UL 1577	IEC 60747-5-5	Quantity
ACNT-H511	-000E	15-mm Stretched SO8	X		X	X	80 per tube
	-500E		X	X	X	X	1000 per reel

To order, choose a part number from the part number column and combine with the desired option from the option column to form an order entry.

# Package Outline Drawing

## ACNT-H511 Stretched SO8 Package

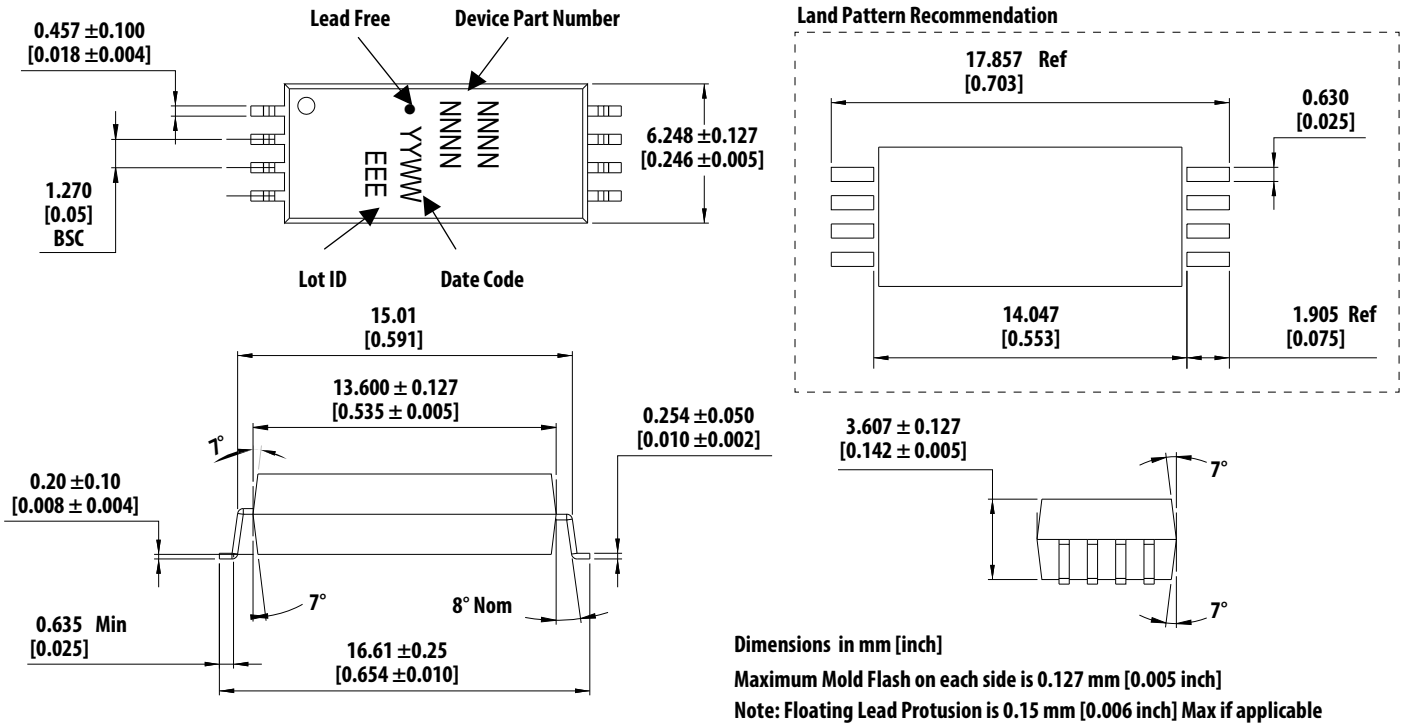

# Solder Reflow Profile

Recommended reflow conditions are as per JEDEC Standard, J-STD-020 (latest revision). Non-halide flux should be used.

## Regulatory Information

The ACNT-H511 is approved by the following organizations:

<b>UL</b>	Approval under UL 1577, component recognition program up to $V_{ISO} = 7500V_{RMS}$ File E55361.
<b>CSA</b>	Approval under CSA Component Acceptance Notice #5, File CA 88324.
<b>IEC 60747-5-5</b>	Maximum Working Insulation Voltage $V_{IORM} = 2262V_{PEAK}$

## Insulation and Safety Related Specifications

Parameter	Symbol	ACNT-H511	Unit	Conditions
Minimum External Air Gap (External Clearance)	L(101)	14.2	mm	Measured from input terminals to output terminals, shortest distance through air.
Minimum External Tracking (External Creepage)	L(102)	15	mm	Measured from input terminals to output terminals, shortest distance path along body.
Minimum Internal Plastic Gap (Internal Clearance)		0.5	mm	Through insulation distance conductor to conductor, usually the straight line distance thickness between the emitter and detector.
Tracking Resistance (Comparative Tracking Index)	CTI	>300	V	DIN IEC 112/VDE 0303 Part 1
Isolation Group		IIIa		Material Group (DIN VDE 0110, 1/89, Table 1)

## IEC 60747-5-5 Insulation Characteristics<sup>a</sup>

Description	Symbol	Characteristic	Unit
Installation Classification per DIN VDE 0110/39, Table 1 for rated mains voltage $\leq 600V_{RMS}$ for rated mains voltage $\leq 1000V_{RMS}$		I – IV I – IV	
Climatic Classification		40/105/21	
Pollution Degree (DIN VDE 0110/39)		2	
Maximum Working Insulation Voltage	$V_{IORM}$	2262	$V_{peak}$
Input to Output Test Voltage, Method b <sup>a</sup> $V_{IORM} \times 1.875 = V_{PR}$ , 100% Production Test with $t_m = 1$ sec, Partial Discharge < 5 pC	$V_{PR}$	4241	$V_{peak}$
Input to Output Test Voltage, Method a <sup>a</sup> $V_{IORM} \times 1.6 = V_{PR}$ , Type and Sample Test, $t_m = 10$ sec, Partial Discharge < 5 pC	$V_{PR}$	3619	$V_{peak}$
Highest Allowable Overvoltage (Transient Overvoltage $t_{ini} = 60$ sec)	$V_{IOTM}$	12000	$V_{peak}$
Safety-limiting values – Maximum Values Allowed in the Event of a Failure			
Case Temperature	$T_S$	150	$^{\circ}C$
Input Current	$I_{S, INPUT}$	230	mA
Output Power	$P_{S, OUTPUT}$	1000	mW
Insulation Resistance at $T_S$ , $V_{IO} = 500V$	$R_S$	$>10^9$	$\Omega$

a. Refer to the optocoupler section of the Isolation and Control Components Designer's Catalog, under Product Safety Regulations section, (IEC 60747-5-5) for a detailed description of Method a and Method b partial discharge test profiles.

**NOTE:** These optocouplers are suitable for safe electrical isolation only within the safety limit data. Maintenance of the safety limit data shall be ensured by means of protective circuits.

## Absolute Maximum Ratings

Parameter	Symbol	Min.	Max.	Unit
Storage Temperature	$T_S$	-55	125	°C
Operating Temperature	$T_A$	-40	105	°C
Average Forward Input Current	$I_{F(avg)}$	—	20	mA
Peak Forward Input Current ( $<1 \mu s$ Pulse Width, $<10\%$ Duty Cycle)	$I_{F(peak)}$	—	80	mA
Peak Transient Input Current ( $\leq 1 \mu s$ pulse width, $<300 ps$ )	$I_{F(trans)}$	—	1	A
Reversed Input Voltage	$V_R$	—	5	V
Input Power Dissipation	$P_{IN}$	—	35	mW
Output Power Dissipation	$P_O$	—	100	mW
Output Current	$I_O$	—	12	mA
Supply Voltage	$V_{CC}$	-0.5	30	V
Output Voltage	$V_O$	-0.5	24	V
Lead Solder Temperature	$T_{LS}$	260°C for 10 sec, 1.6 mm below seating plane		
Solder Reflow Temperature Profile		Refer to the <a href="#">Solder Reflow Profile</a> section.		

## Recommended Operating Conditions

Parameter	Symbol	Min.	Max.	Unit
Supply Voltage	$V_{CC}$	4.5	24	V
Input Current, High Level	$I_{FH}$	10	18	mA
Operating Temperature	$T_A$	-40	105	°C
Forward Input Voltage (OFF)	$V_{F(OFF)}$	—	0.8	V

## Electrical Specifications (DC)

Over recommended operating  $T_A = -40^\circ\text{C}$  to  $+105^\circ\text{C}$ , supply voltage ( $4.5\text{V} \leq V_{CC} \leq 24\text{V}$ ) and unless otherwise specified. All typical values are at  $T_A = 25^\circ\text{C}$ .

Parameter	Symbol	Min.	Typ.	Max.	Unit	Conditions			Figure
Current Transfer Ratio	$CTR^a$	31	50	80	%	$T_A = 25^\circ\text{C}$	$V_O = 0.4\text{V}$	$V_{CC} = 5\text{V}$ $I_F = 12\text{mA}$	2
		21	—	—	%		$V_O = 0.5\text{V}$		
Logic Low Output Voltage	$V_{OL}$	—	0.2	0.4	V	$T_A = 25^\circ\text{C}$	$I_O = 3\text{mA}$	$V_{CC} = 5\text{V}$ $I_F = 12\text{mA}$	
		—	0.2	0.5	V		$I_O = 1.6\text{mA}$		

Parameter	Symbol	Min.	Typ.	Max.	Unit	Conditions			Figure
Logic High Output Current	$I_{OH}$	—	0.014	0.5	$\mu\text{A}$	$T_A = 25^\circ\text{C}$	$V_O = V_{CC} = 5.5\text{V}$	$I_F = 0\text{ mA}$	4
		—	0.06	1			$V_O = V_{CC} = 24\text{V}$		
		—	—	80			$V_O = V_{CC} = 24\text{V}$		
Logic Low Supply Current	$I_{CCL}$	—	200	400	$\mu\text{A}$		$I_F = 12\text{ mA}$ , $V_O = \text{open}$ , $V_{CC} = 24\text{V}$		
Logic High Supply Current	$I_{CCH}$	—	—	2	$\mu\text{A}$		$I_F = 0\text{ mA}$ , $V_O = \text{open}$ , $V_{CC} = 24\text{V}$		
Input Forward Voltage	$V_F$	1.10	1.45	1.70	V		$I_F = 12\text{ mA}$	1	
Input Reversed Breakdown Voltage	$BV_R$	7	—	—	V		$I_R = 10\ \mu\text{A}$		
Temperature Coefficient of Forward Voltage	$\Delta V_F / \Delta T_A$	—	-1.5	—	mV/°C		$I_F = 12\text{ mA}$		
Input Capacitance	$C_{IN}$	—	20	—	pF		$f = 1\text{ MHz}$ , $V_F = 0$		

a. Current Transfer Ratio in percent is defined as the ratio of output collector current,  $I_O$ , to the forward LED input current,  $I_F$ , times 100%.

## Switching Specifications

Over recommended operating ( $T_A = -40^\circ\text{C}$  to  $+105^\circ\text{C}$ ),  $I_F = 12\text{ mA}$ , ( $4.5\text{V} \leq V_{CC} \leq 24\text{V}$ ), unless otherwise specified.

Parameter	Symbol	Min.	Typ.	Max.	Unit	Test Conditions		Figure
Propagation Delay Time to Logic Low at Output	$T_{PHL}$	—	0.1	2.0	$\mu\text{s}$	$T_A = 25^\circ\text{C}$	Pulse: $f = 10\text{ kHz}$ , Duty cycle = 50%, $V_{CC} = 5.0\text{V}$ , $R_L = 1.6\text{ k}\Omega$ , $C_L = 15\text{ pF}$ , $V_{THHL} = 1.5\text{V}$	12
		—	—	2.0	$\mu\text{s}$			5, 12
		—	0.15	2.0	$\mu\text{s}$	$T_A = 25^\circ\text{C}$	Pulse: $f = 10\text{ kHz}$ , Duty cycle = 50%, $V_{CC} = 24\text{V}$ , $R_L = 8.2\text{ k}\Omega$ , $C_L = 15\text{ pF}$ , $V_{THHL} = 1.5\text{V}$	12
		—	—	2.0	$\mu\text{s}$			6, 12
Propagation Delay Time to Logic High at Output	$T_{PLH}$	—	0.4	2.0	$\mu\text{s}$	$T_A = 25^\circ\text{C}$	Pulse: $f = 10\text{ kHz}$ , Duty cycle = 50%, $V_{CC} = 5.0\text{V}$ , $R_L = 1.6\text{ k}\Omega$ , $C_L = 15\text{ pF}$ , $V_{THLH} = 2.0\text{V}$	12
		—	—	2.0	$\mu\text{s}$			5, 12
		—	0.4	2.0	$\mu\text{s}$	$T_A = 25^\circ\text{C}$	Pulse: $f = 10\text{ kHz}$ , Duty cycle = 50%, $V_{CC} = 24\text{V}$ , $R_L = 8.2\text{ k}\Omega$ , $C_L = 15\text{ pF}$ , $V_{THLH} = 2.0\text{V}$	12
		—	—	2.0	$\mu\text{s}$			6, 12
Propagation Delay Difference Between Any Two Parts <sup>a</sup>	tpsk	—	0.3	2.0	$\mu\text{s}$	$T_A = 25^\circ\text{C}$	Pulse: $f = 10\text{ kHz}$ , Duty cycle = 50%, $V_{CC} = 5.0\text{V}$ , $R_L = 1.6\text{ k}\Omega$ , $C_L = 15\text{ pF}$ , $V_{THHL} = 1.5\text{V}$ , $V_{THLH} = 2.0\text{V}$	
		—	0.3	2.0	$\mu\text{s}$	$T_A = 25^\circ\text{C}$	Pulse: $f = 10\text{ kHz}$ , Duty cycle = 50%, $V_{CC} = 24\text{V}$ , $R_L = 8.2\text{ k}\Omega$ , $C_L = 15\text{ pF}$ , $V_{THHL} = 1.5\text{V}$ , $V_{THLH} = 2.0\text{V}$	

Parameter	Symbol	Min.	Typ.	Max.	Unit	Test Conditions	Figure
Common-Mode Transient Immunity at Logic High Output <sup>b</sup>	CM <sub>H</sub>	—	40	—	kV/μs	T <sub>A</sub> = 25°C V <sub>CM</sub> = 1500V, I <sub>F</sub> = 0 mA, R <sub>L</sub> = 1.0 kΩ or 1.6 kΩ, V <sub>CC</sub> = 5V	13
Common-Mode Transient Immunity at Logic Low Output <sup>c</sup>	CM <sub>L</sub>	—	40	—	kV/μs	T <sub>A</sub> = 25°C V <sub>CM</sub> = 1500V, I <sub>F</sub> = 12 mA, R <sub>L</sub> = 1.6 kΩ, V <sub>CC</sub> = 5V	13

- The difference between t<sub>PLH</sub> and t<sub>PHL</sub> between any two parts under the same test condition.
- Common transient immunity in a Logic High level is the maximum tolerable (positive) dV<sub>CM</sub>/dt on the rising edge of the common-mode pulse, V<sub>CM</sub>, to assure that the output remains in a Logic High state.
- Common-mode transient immunity in a Logic Low level is the maximum tolerable (negative) dV<sub>CM</sub>/dt on the falling edge of the common-mode pulse signal, V<sub>CM</sub> to assure that the output remains in a Logic Low state.

## Package Characteristics

All Typical at T<sub>A</sub> = 25°C.

Parameter	Symbol	Min.	Typ.	Max.	Unit	Test Conditions
Input-Output Momentary Withstand Voltage <sup>a</sup>	V <sub>ISO</sub>	7500	—	—	V <sub>RMS</sub>	RH ≤ 50%, t = 1 min., T <sub>A</sub> = 25°C
Input-Output Resistance <sup>a</sup>	R <sub>I-O</sub>	—	10 <sup>14</sup>	—	Ω	V <sub>I-O</sub> = 500V DC
Input-Output Capacitance <sup>a</sup>	C <sub>I-O</sub>	—	0.6	—	pF	f = 1 MHz, T <sub>A</sub> = 25°C

- Device considered a two terminal device: pins 2 and 3 shorted together and pins 5, 6, and 8 shorted together.

Figure 1: Input Current vs. Forward Voltage

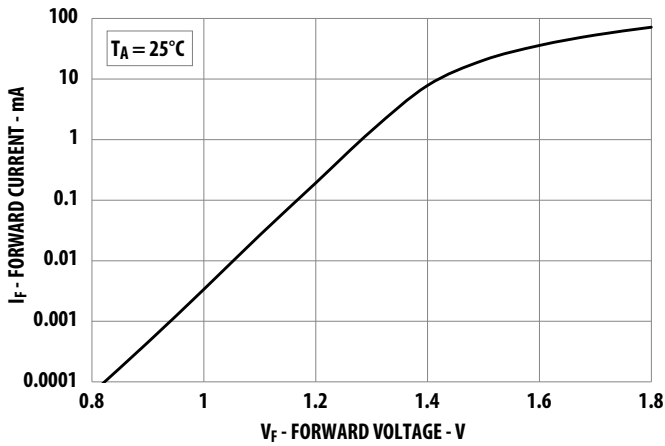

Figure 2: Typical Current Transfer Ratio vs. Temperature

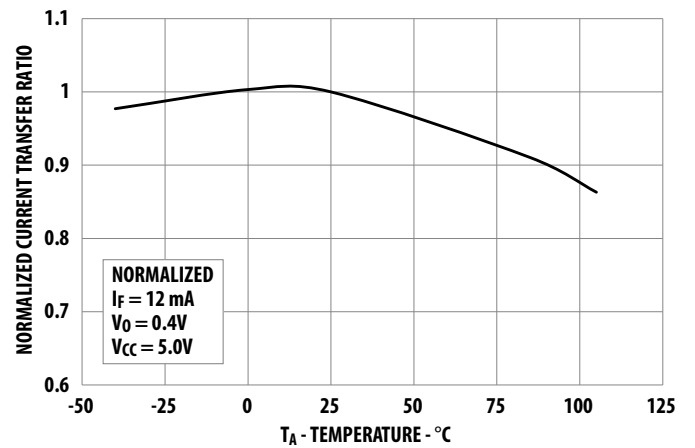

Figure 3: Typical Current Transfer Ratio vs. Temperature

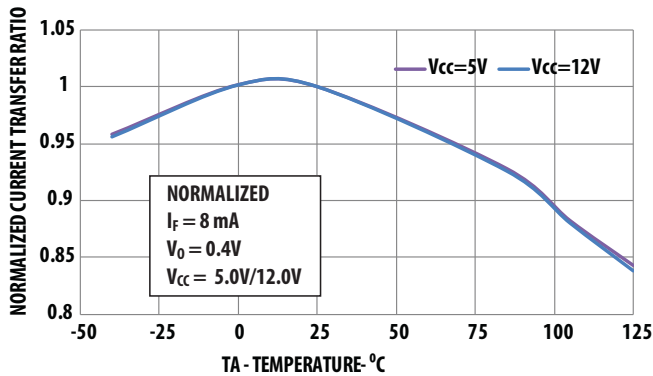

Figure 4: Typical Logic High Output Current vs. Temperature

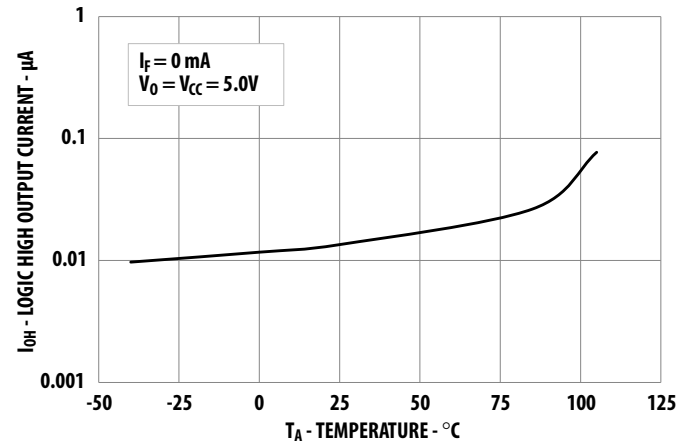

Figure 5: Typical Propagation Delay vs. Temperature

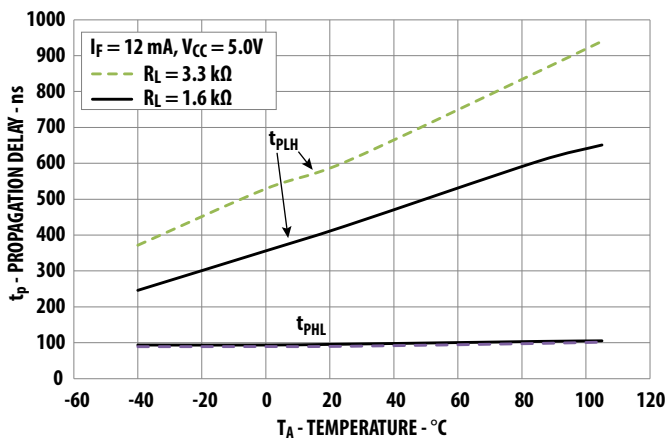

Figure 6: Typical Propagation Delay vs. Temperature

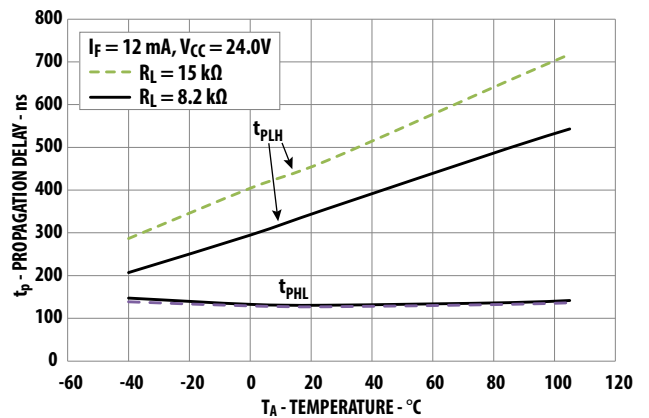

Figure 7: Typical Propagation Delay vs. Load Resistance

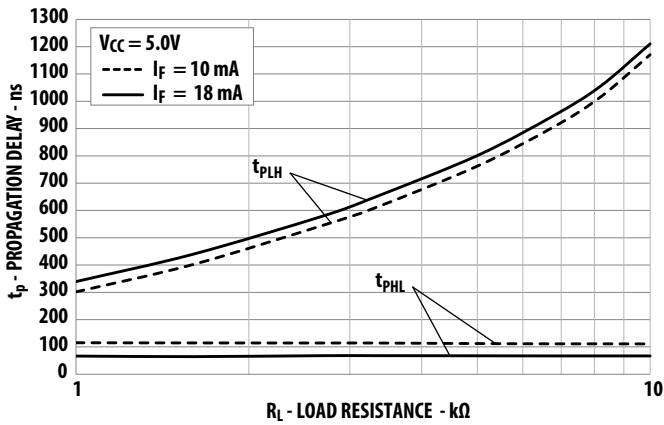

Figure 8: Typical Propagation Delay vs. Supply Voltage

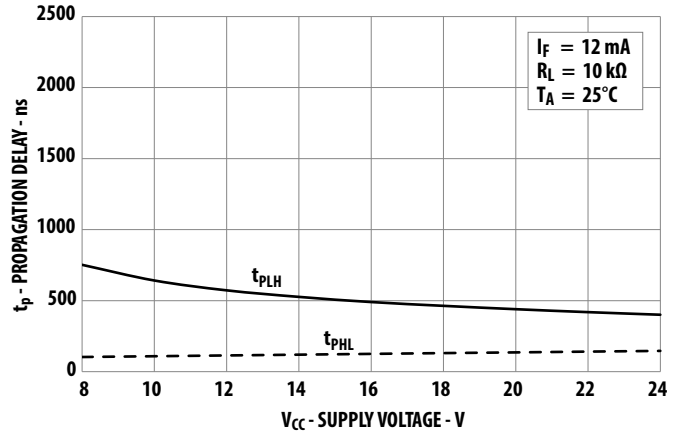

Figure 9: Typical Propagation Delay vs. Input Current

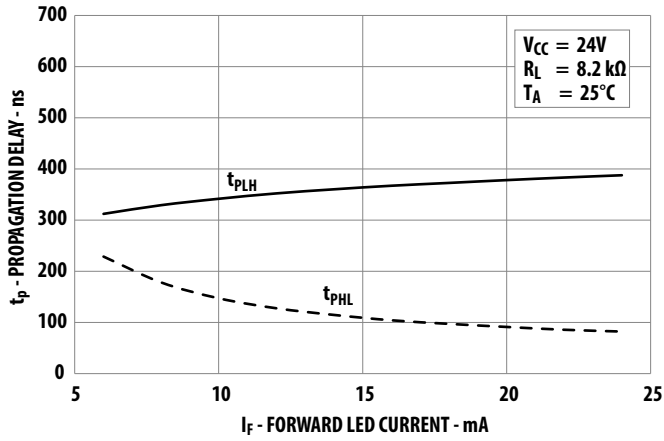

Figure 10: Current Transfer Ratio vs Input Current

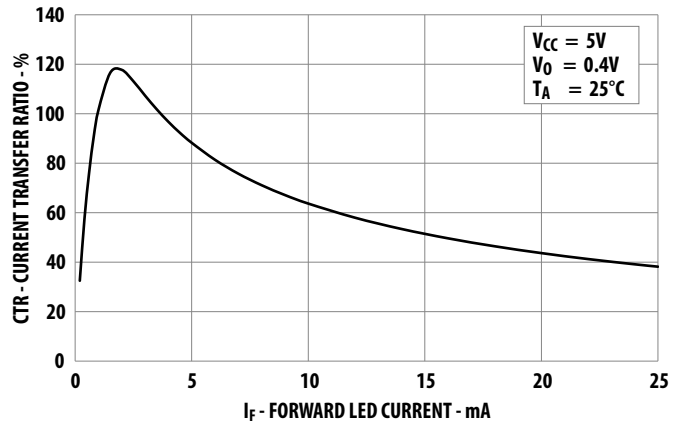
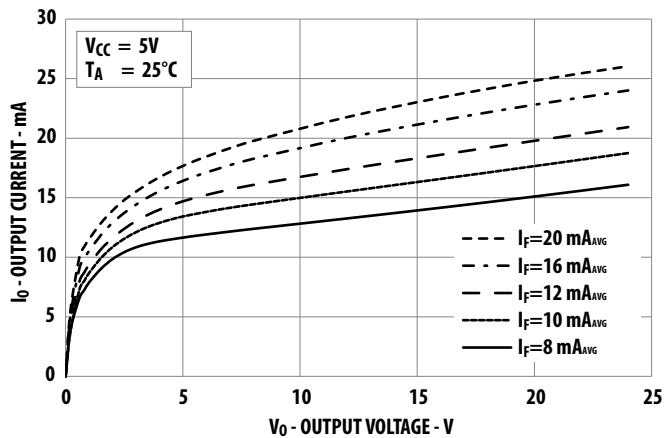

Figure 11: DC Pulse Transfer Characteristic



# Test Circuits

Figure 12: Switching Test Circuits

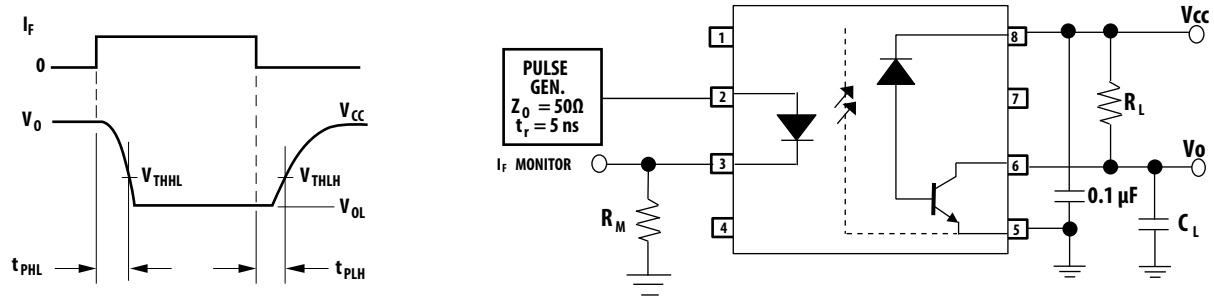
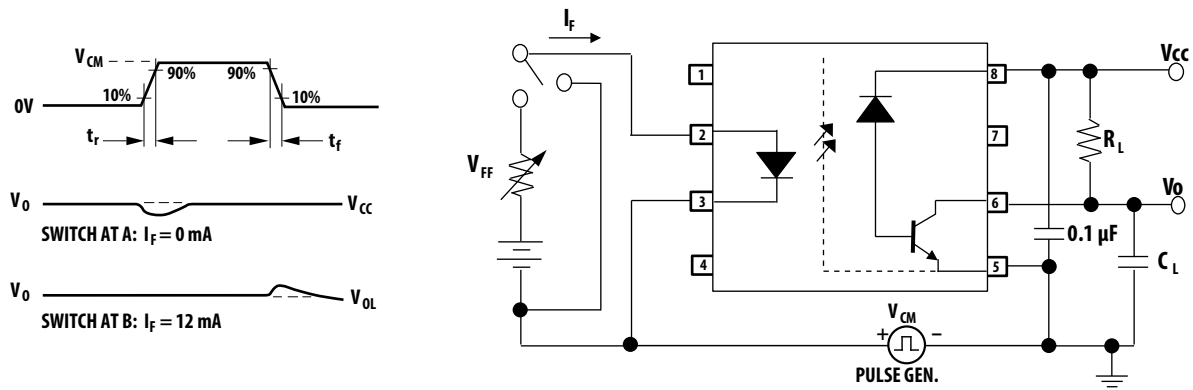

Figure 13: Test Circuit for Transient Immunity and Typical Waveforms



Broadcom, the pulse logo, Connecting everything, Avago Technologies, Avago, and the A logo are among the trademarks of Broadcom and/or its affiliates in the United States, certain other countries, and/or the EU.

Copyright © 2019 Broadcom. All Rights Reserved.

The term “Broadcom” refers to Broadcom Inc. and/or its subsidiaries. For more information, please visit [www.broadcom.com](http://www.broadcom.com).

Broadcom reserves the right to make changes without further notice to any products or data herein to improve reliability, function, or design. Information furnished by Broadcom is believed to be accurate and reliable. However, Broadcom does not assume any liability arising out of the application or use of this information, nor the application or use of any product or circuit described herein, neither does it convey any license under its patent rights nor the rights of others.

