

## *High Voltage Power Operational Amplifiers*



### **FEATURES**

- Monolithic MOS Technology for Amplifier Core
- High Voltage Operation (200V Output)
- Current Limit with Over-current Flag
- High Output Current 4A Peak or 10A Peak
- Amplifier Disable feature

### **APPLICATIONS**

- High Density Voltage or Current Supplies
- Electrostatic Transducer and Deflection
- Deformable Mirror Focusing
- Piezo Electric Positioning

### **DESCRIPTION**

The PA164 and PA165 are high voltage MOSFET operational amplifiers with a monolithic amplifier core designed for high density power applications with high output currents or voltages. Both devices are designed for operation up to 200V, with the PA164 providing 1A and the PA165 4A of continuous current. Separate supplies for the amplifier core and the output stage optimize the overall power dissipation in the devices. Both devices offer a wide-range, temperature compensated current limit. An additional over-current flag allows for a flexible implementation of system protection, with an output disable function adding another layer of optional protection. External compensation provides the user flexibility in choosing optimum gain and bandwidth for the application.

Figure 1: PA 164/165 Block Diagram

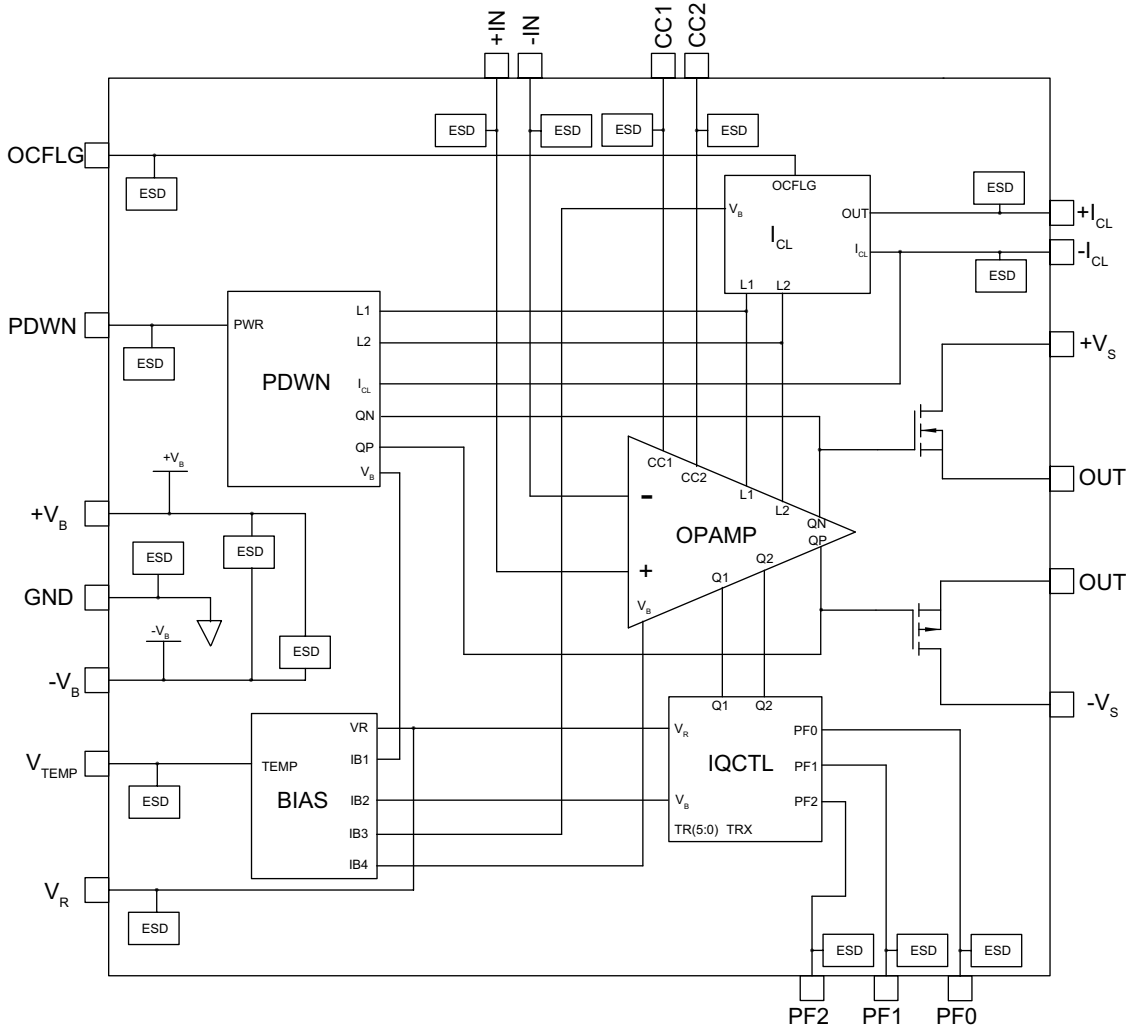

**PINOUT DESCRIPTION TABLE**

Pin Number	Name	Description
1	GND	Amplifier ground connection
2, 3, 4, 5, 6, 7	NC	No connection pin. Do not connect anything to the pin
8	+V <sub>B</sub>	Positive boost voltage pin
9, 10, 11, 12, 13	+V <sub>S</sub>	Positive supply voltage pin
14, 15, 16, 17, 18	OUT	Output current sourcing pins
19	+I <sub>CL</sub>	Current Limit Sense pin Connect this pin to DUT side of the current limit resistor, (refer to typical connection Figure 2)
20, 32, 33, 34, 40, 41, 51, 52	NIC	Pins are not connected internally
21	-I <sub>CL</sub>	Current Limit Sense pin Connect this pin to Load side of the current limit resistor, (refer to typical connection Figure 2)
22, 23, 24, 25, 26	OUT	Output current sinking pins
27, 28, 29, 30, 31	-V <sub>S</sub>	Negative supply voltage pin
35	-V <sub>B</sub>	Negative boost voltage pins
36	CC2	Compensation Capacitor pin Connect a compensation capacitor from this pin to ground
37	CC1	Compensation capacitor pin Connect a compensation capacitor from this pin to ground
38	-IN	Inverting input pin
39	+IN	Non - Inverting Input pin
42	V <sub>R</sub>	Pin connected to an internal 5V reference. Connect a 0.1μF bypass capacitor between this pin and GND. Do not use this pin as a reference for external components.
43	V <sub>TEMP</sub>	Temperature sensor output pin
44	PDWN	Power Down pin
45	OCFLG	Over Current Flag High = No current limit, Low = Current limit, (must be connected to 5V source through 5K resistor)
46, 47, 48	PFO, PF1, PF2	These pins should be shorted when using the PA165 and left open when using the PA164
49, 50	GND	Ground Connection, connect both these pins and pin 1 to ground.

Figure 2: Typical Connection

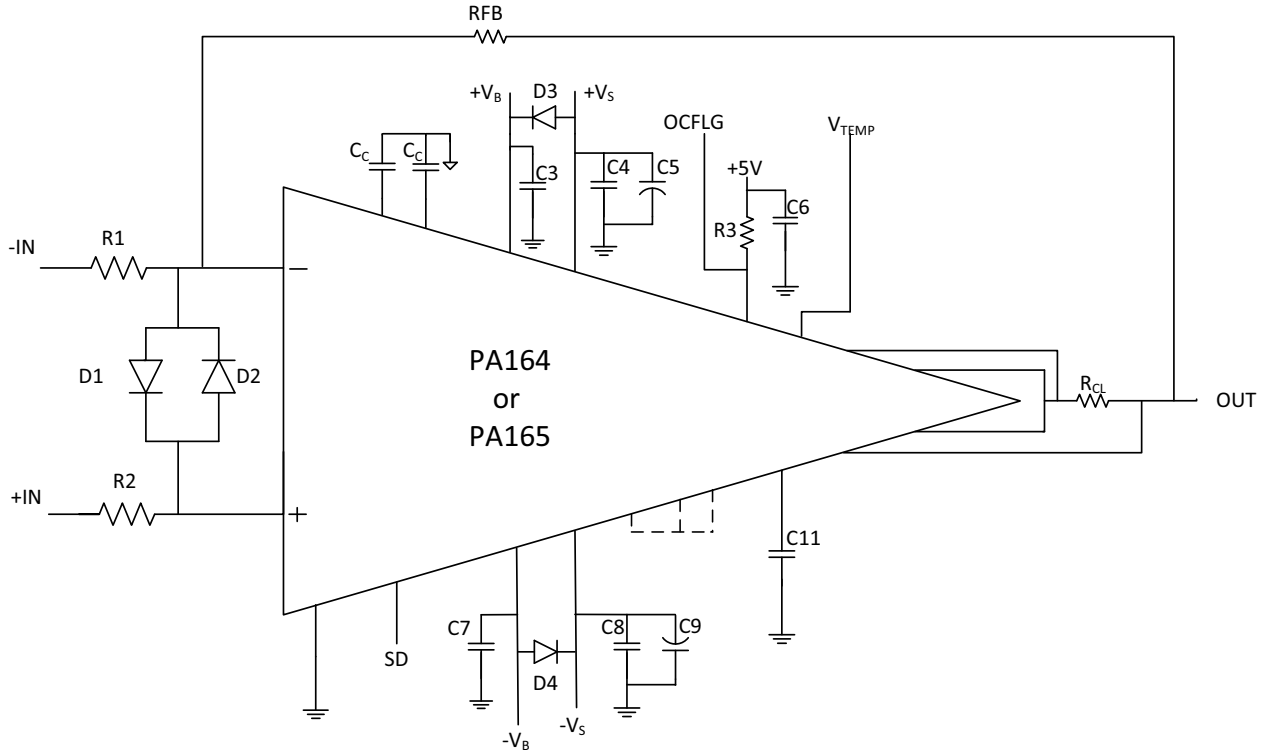

**SPECIFICATIONS**

Unless otherwise noted;  $T_C = 25^\circ\text{C}$ ,  $C_{C1} = C_{C2} = 3.3\text{pF}$ . The power supply voltages are set at  $\pm V_S = \pm 100\text{V}$ , and  $\pm V_B = \pm V_S$ . Load  $R_L = 1\text{ k}\Omega$ .

**ABSOLUTE MAXIMUM RATINGS**

Parameter	Symbol	Min	Max	Units
Supply Voltage, total <sup>1</sup>	$+V_S$ to $-V_S$		205	V
Supply Voltage <sup>2</sup>	$+V_B$	$+V_S$	$+V_S+15$	V
Supply Voltage	$-V_B$	$-V_S-15$	$-V_S$	V
Supply Voltage <sup>3</sup>	$+V_B$ to $-V_B$		235	V
Output Current, peak, within SOA (PA164)			4	A
Output Current, peak, within SOA (PA165)			10	A
Power Dissipation, internal, continuous, PA164 <sup>4</sup>			28	W
Power Dissipation, internal, continuous, PA165 <sup>4</sup>			32	W
Input Voltage, common mode		$-V_B+10$	$+V_B-10$	V
Input Voltage, Differential			$\pm 22$	V
Peak Reflow Temperature, 30s			250	$^\circ\text{C}$
Temperature, junction			150	$^\circ\text{C}$
Temperature, storage		-40	150	$^\circ\text{C}$
Operating Temperature Range, case		-40	+85	$^\circ\text{C}$

1. Valid only for device temperature of  $25^\circ\text{C}$  or higher.
2. The supply of a boost voltage is optional and can be replaced by the general supply voltage ( $+V_S$ ,  $-V_S$ ). Please also note the restriction of the overall supply voltage  $+V_B$  to  $-V_B$ .
3. If  $V_S$  is also used for  $V_B$ , then the maximum voltage can't exceed the 205V.
4. The case temperature is  $25^\circ\text{C}$

## INPUT

Parameter	Test Conditions	Min	Typ	Max	Units
Offset Voltage, initial			-2	±20	mV
Offset Voltage vs. Temperature	-25°C to +85°C		6	250	μV/°C
Offset Voltage vs. Supply			0.2		μV/V
Offset Voltage vs. Time			80		μV/kh
Bias Current, initial			23	200	pA
Bias Current vs. Supply			2		pA/V
Offset Current, initial			50	200	pA
Input Impedance, DC			10 <sup>11</sup>		Ω
Input Capacitance			3		pF
Common Mode Voltage Range		-V <sub>B</sub> +15		+V <sub>B</sub> -15	V
Common Mode Rejection, DC	V <sub>CM</sub> = ±90V DC	97	115		dB
Noise	1 MHz		13		nV/√Hz

## GAIN

Parameter	Test Conditions	Min	Typ	Max	Units
Open Loop @ 15 Hz	R <sub>L</sub> =5 kΩ	90	118		dB
Gain Bandwidth Product @ 1 MHz			20		MHz
Power Bandwidth	150V <sub>p-p</sub>		80		kHz

**OUTPUT**

Parameter	Test Conditions	PA164			PA165			Units
		Min	Typ	Max	Min	Typ	Max	
Voltage Swing (no boost voltage) $ V_B = V_S $	$I_{OUT}=1A$	$+V_S-10$	$+V_S-8$		*	*		V
	$I_{OUT}=-1A$	$-V_S+10$	$-V_S+6$		*	*		V
Voltage Swing (with boost voltage, $ V_B = V_S +10V$ )	$I_{OUT}=1A$	$+V_S-1.8$	$+V_S-1.3$			*		V
	$I_{OUT}=-1A$	$-V_S+2.2$	$-V_S+1.6$			*		V
Voltage Swing (with boost voltage, $ V_B = V_S +10V$ )	$I_{OUT} = 4A$				$+V_S-2$	$+V_S-1.5$		V
	$I_{OUT} = -4A$				$-V_S+2.8$	$-V_S+2.3$		V
Current, peak, within SOA		4				10		A
Current, continuous, within SOA		1				4 <sup>1</sup>		A
Settling Time to 0.1% <sup>2</sup>	10V step, $A_V = -10$		1.5			3		$\mu s$
Slew Rate <sup>2</sup>	$A_V = -10, C_C = 0pF$		35			*		V/ $\mu s$
Slew Rate	$A_V = -10,$ $C_C = 3.3pF$		29			*		V/ $\mu s$

1. Do not exceed SOA when operating with  $|V_B|=|V_S|$ . Refer to Figure 4 for SOA, and Figure 18, 19, for Output Voltage Swing.
2. Confirmed by design, but not tested in production.

**CURRENT LIMIT**

Parameter	Test Conditions	Min	Typ	Max	Units
Absolute Accuracy	+25°C to 85°C		10		%
Temperature Dependency	+25°C to 85°C		0.05		%/K
Clamping Settling Time <sup>1</sup>	Short to ground, settling to the $\pm 10\%$ of limit		3		$\mu s$
Current Limit Range, PA164 <sup>1</sup>		10		1000	mA
Current Limit Range, PA165 <sup>1</sup>		10		4000	mA
Current Limit Delay (OC Flag)	50mA current limit, 10V output voltage, short to ground		600		ns
Current Limit Circuit Input Bias/ Leakage Current			<1		$\mu A$

1. Confirmed by design, but not tested in production. Setting current limit below 10mA may damage the part.

## POWER SUPPLY

Parameter	Test Conditions	Min	Typ	Max	Units
Supply Voltage $V_S=+V_S(-V_S)$		20		205	V
Boost Supply Voltage $V_B=+V_B(-V_B)$		30		$V_S+30^1$	V
Current, Quiescent			5.2	10	mA

1. Please also note the conditions under ABSOLUTE MAXIMUM RATINGS

## THERMAL

Parameter	Test Conditions	PA164			PA165			Units
		Min	Typ	Max	Min	Typ	Max	
Resistance, AC, junction to case	$F \geq 60$ Hz		2.4	3.2		1.1	2.8	°C/W
Resistance, DC, junction to case	$F < 60$ Hz		3.4	4.4		1.5	3.9	°C/W
Resistance, junction to air	Full temperature range		34			*		°C/W
Temperature Range, case	Meet full range specs	-25		+85	*		*	°C

## TEMPERATURE SENSOR

Parameter	Test Conditions	Min	Typ	Max	Units
Temp Sensor Output Voltage, $V_{TEMP}$	$T_C=25^\circ\text{C}$	1.8	2	2.2	V
Temp Sensor "Gain" <sup>1</sup>	$T_C=25^\circ\text{C}$ to $+85^\circ\text{C}$	14.5	14.7	14.9	mV/°C
Temperature Accuracy	$T_C=25^\circ\text{C}$ to $+85^\circ\text{C}$		$\pm 2.2$		°C

1. Temperature sensor gain confirmed by design but not tested in production.

**SAFE OPERATING AREA (SOA)**

The MOSFET output stage of the PA164 and PA165 is not limited by secondary breakdown considerations as in bipolar output stages. Only thermal considerations and current handling capabilities limit the SOA (see Safe Operating Area graph). The output stage is protected against transient flyback by the parasitic body diodes of the output stage MOSFET structure. However, for protection against sustained high energy flybacks external fast recovery diodes must be used.

**Figure 3: PA164 Safe Operating Area (SOA)**

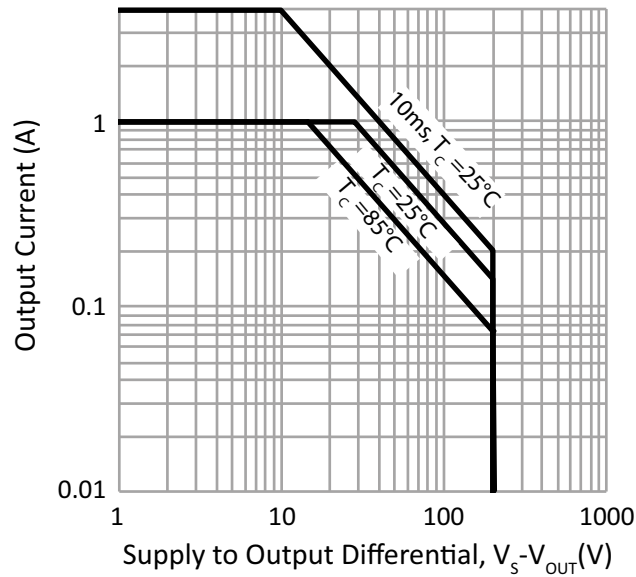

**Figure 4: PA165 Safe Operating Area (SOA)**

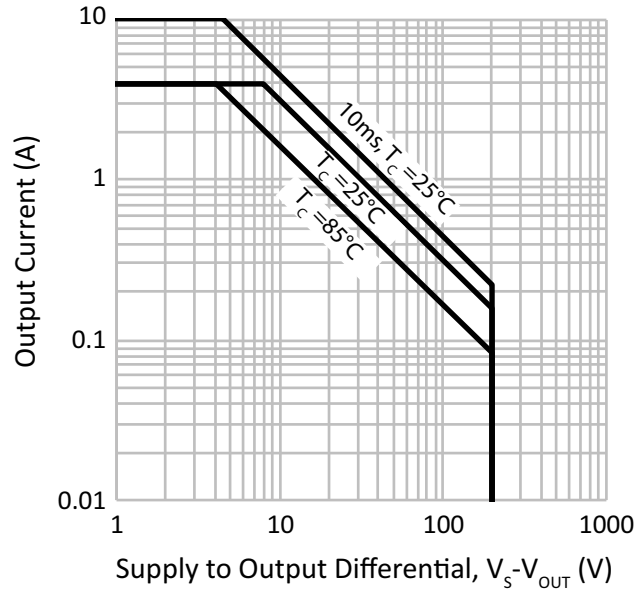

Figure 5: Power Derating

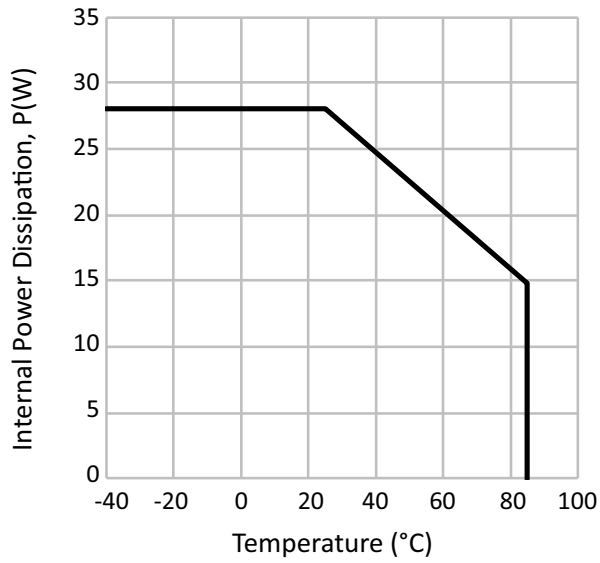

Figure 6: Current Limit vs. Current Limit Resistor

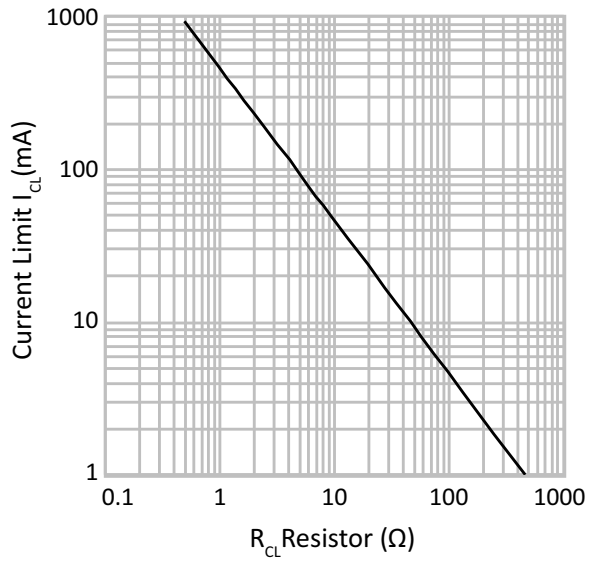

Figure 7: Input Noise

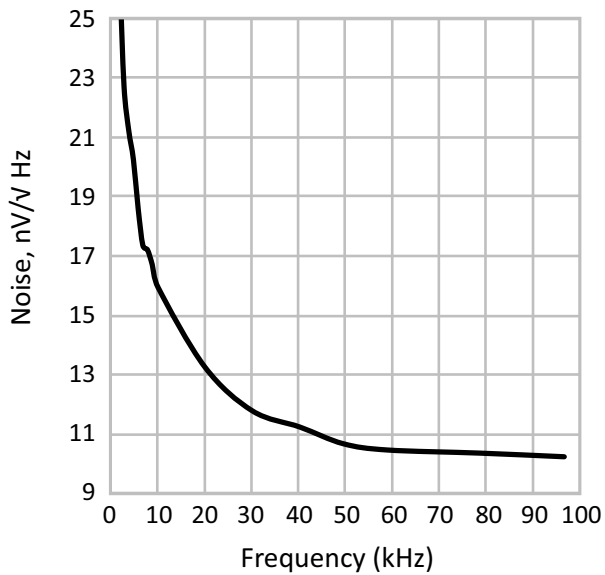

Figure 8: Power Response vs. Compensation

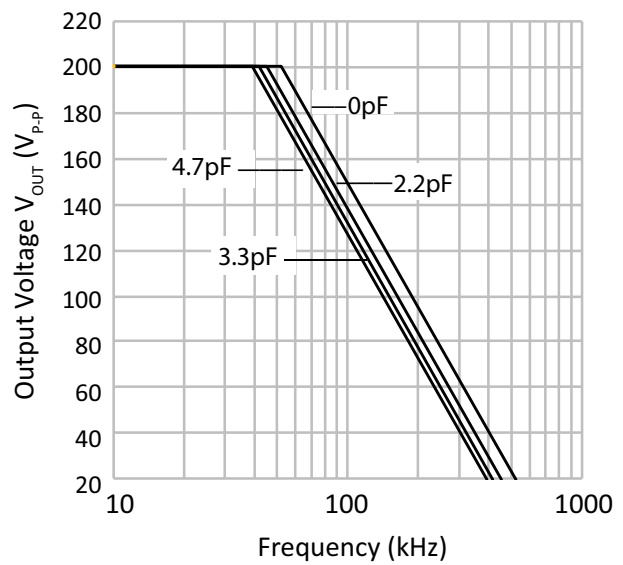

Figure 9:  $V_{TEMP}$  vs. Temperature

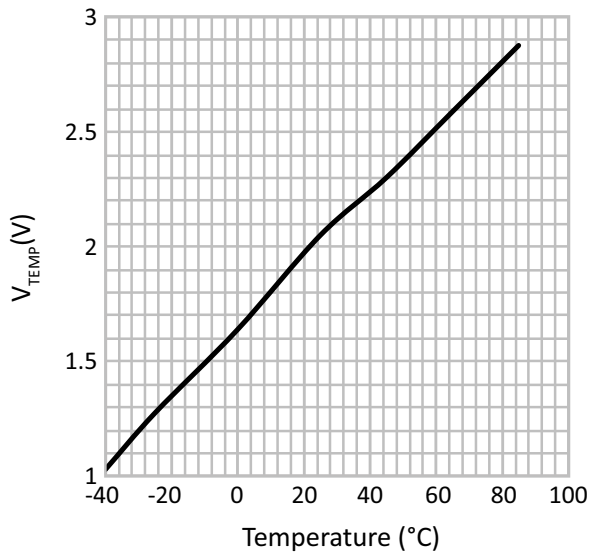

Figure 10:  $I_Q$  vs. Supply

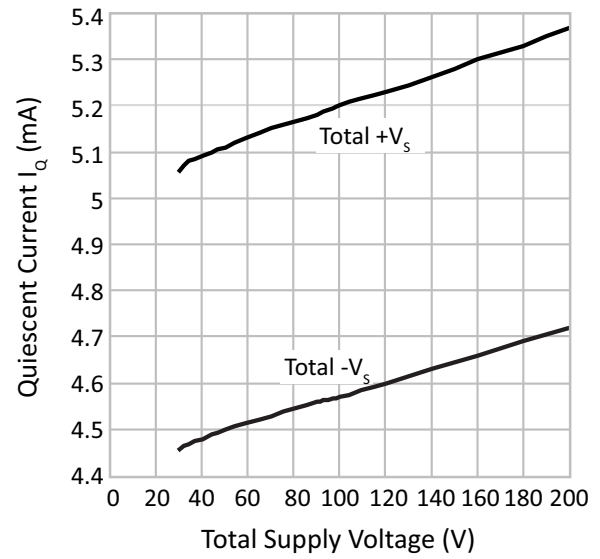

Figure 11: PA164  $V_S$  Quiescent Current vs. Temperature

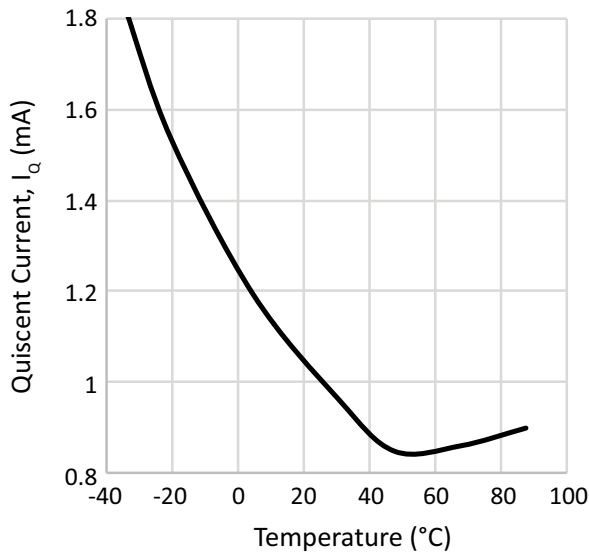
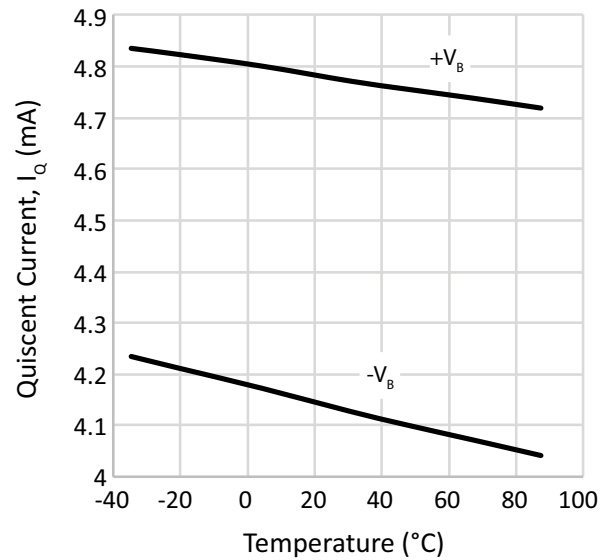
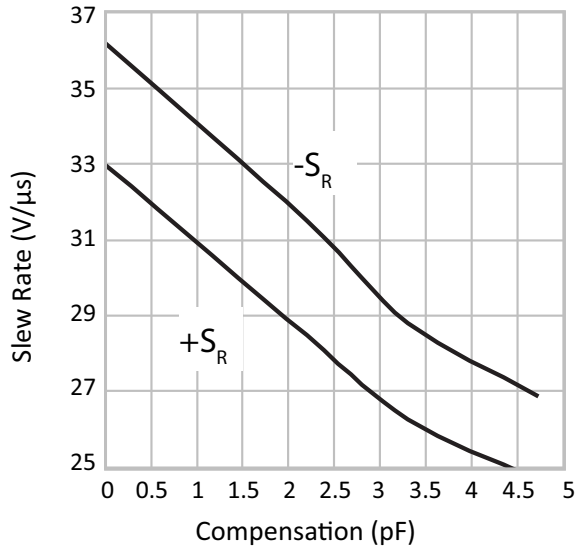

Figure 12: PA164  $V_B$  Quiescent Current vs. Temperature



**Figure 13: PA164 Slew Rate vs. Compensation**



**Figure 14: PA164 Open Loop Phase Response,  $C_C = 0pF$**

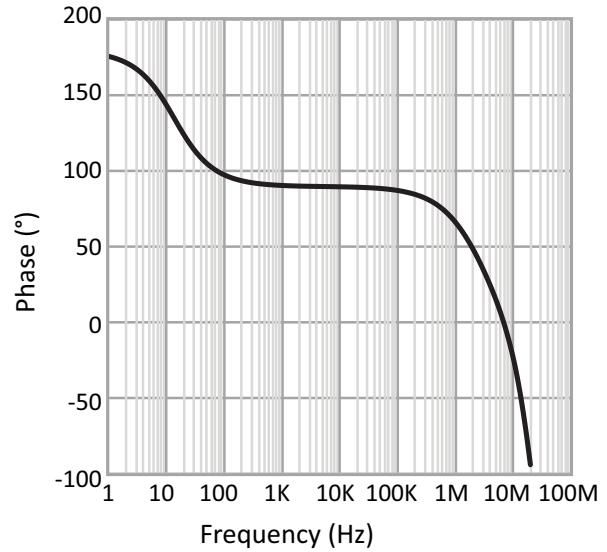

**Figure 15: PA164 Open Loop Frequency Response,  $C_C = 0pF$**

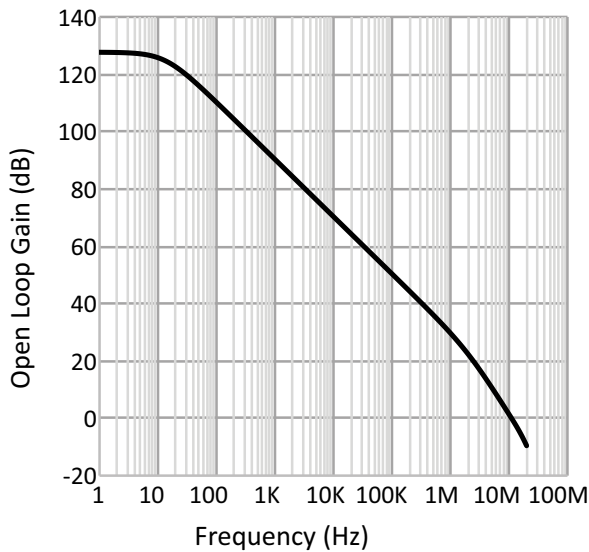

**Figure 16: PA164 Output Voltage Swing (with additional boost voltage)**

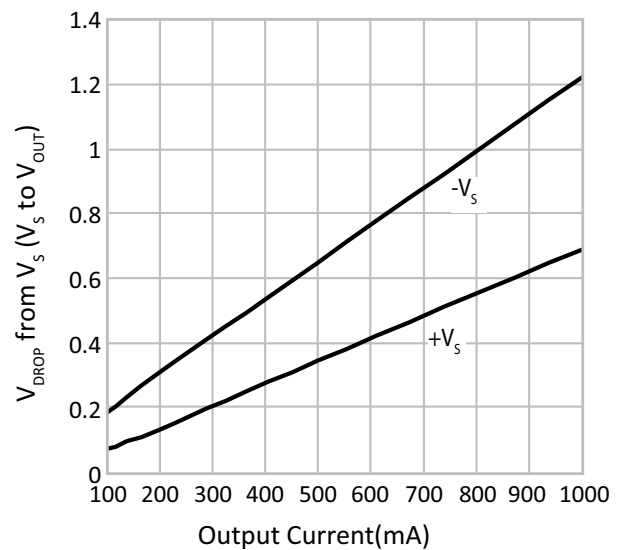

**Figure 17: PA164 Output Voltage Swing (without additional boost voltage)**

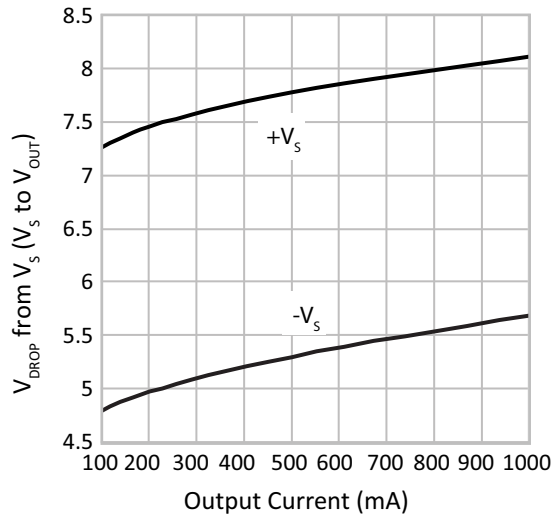

**Figure 18: PA164 Small Signal Pulse Response**

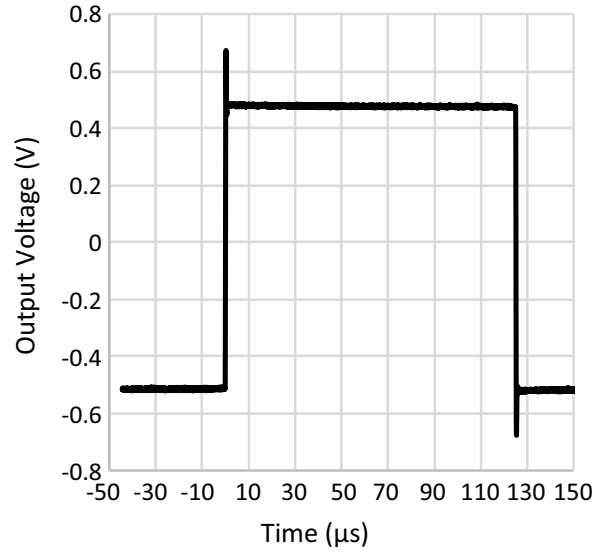

**Figure 19: PA165 Output Voltage Swing (with additional boost voltage)**

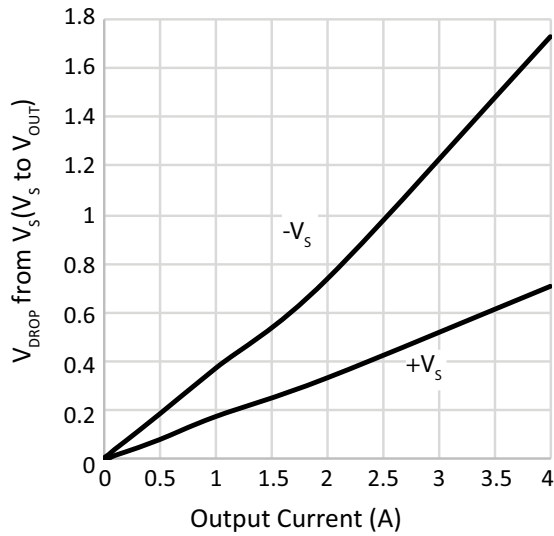

**Figure 20: PA165 Output Voltage Swing (without additional boost voltage)**

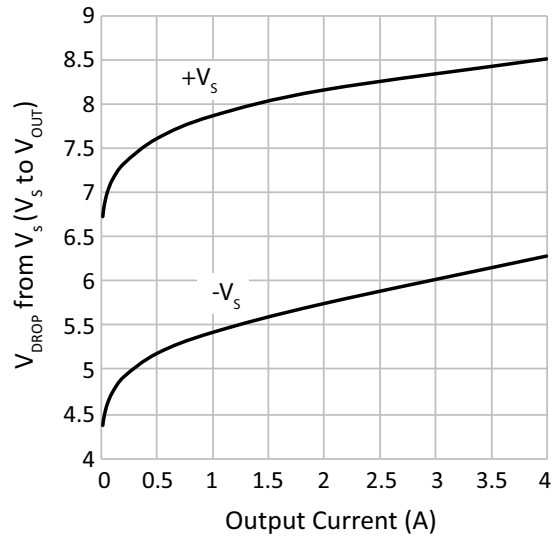

**Figure 21: PA165 Open Loop Phase Response,  $C_C=0pF$**

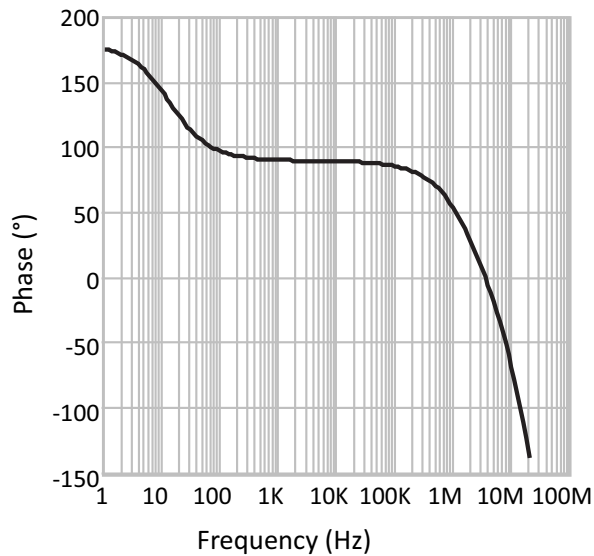

**Figure 22: PA165 Open Loop Frequency Response,  $C_C=0pF$**

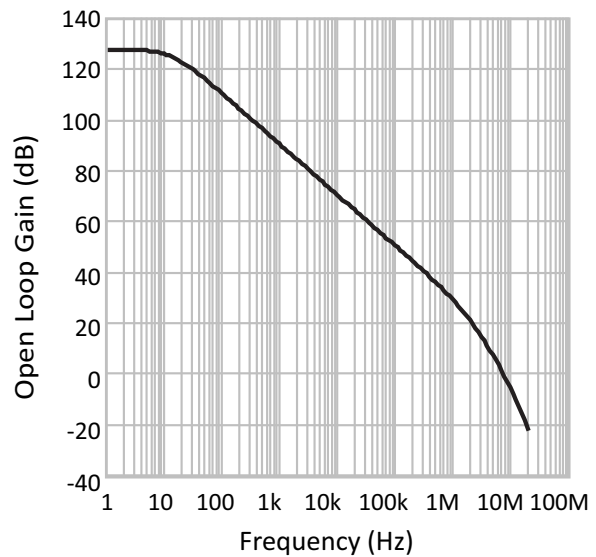

Figure 23: PA165 Small Signal Pulse

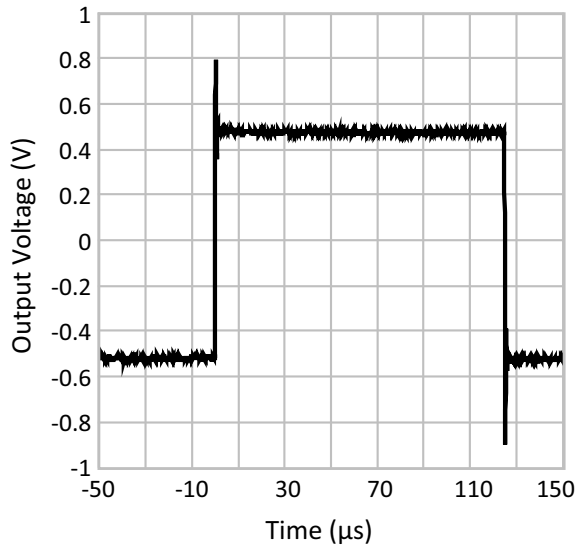

Figure 24: PA165 Slew Rate vs. Compensation

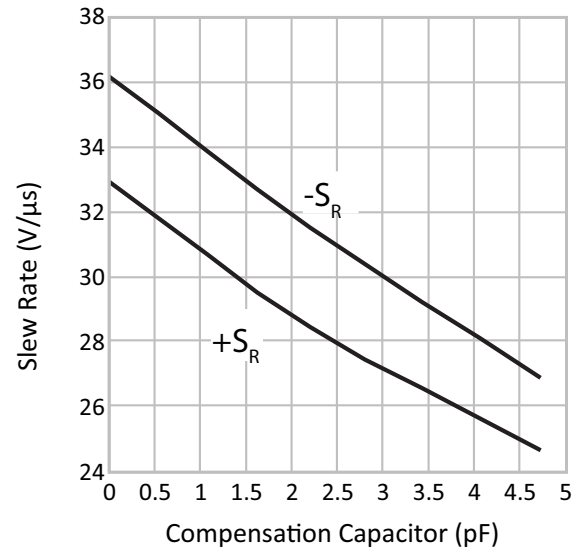

Figure 25: PA165  $V_S$  Quiescent Current vs. Temperature

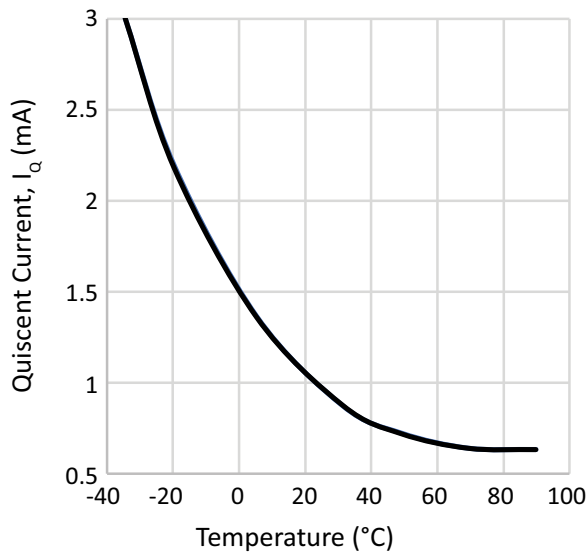
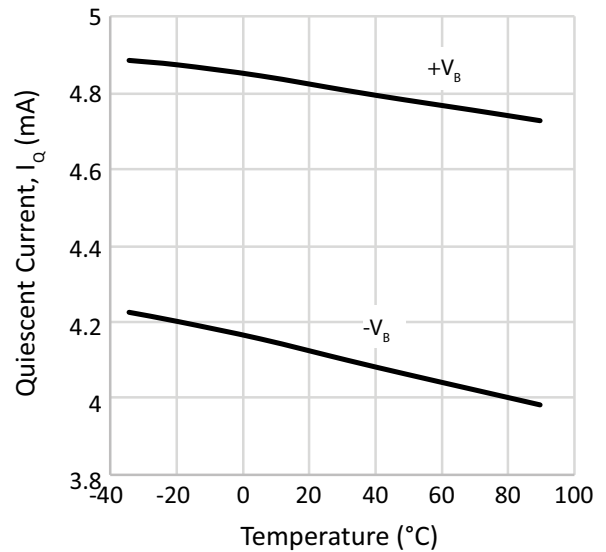

Figure 26: PA165  $V_B$  Quiescent Current vs. Temperature



## GENERAL

Please read Application Note 1 “General Operating Considerations” which covers stability, supplies, heat sinking, mounting, current limit, SOA interpretation, and specification interpretation. Visit [www.apexanalog.com](http://www.apexanalog.com) for Apex Microtechnology’s complete Application Notes library, Power Design Tool, Technical Seminar Workbook, and Evaluation Kits.

## BOOST OPERATION

With the boost feature the small signal stages of the amplifier are operated at higher supply voltages than the amplifier’s high current output stage.  $+V_B$  and  $-V_B$  are connected to the small signal stages and  $+V_S$  and  $-V_S$  are connected to the high current output stage. An additional 5V on the  $+V_B$  and  $-V_B$  pins is sufficient to allow the small signal stages to drive the output stage into the triode region and improve the output voltage swing for extra efficient operation when required. When the boost feature is not needed,  $+V_S$  and  $-V_S$  are connected to the  $+V_B$  and  $-V_B$  pins respectively. The  $+V_B$  and  $-V_B$  pins must not be operated at supply voltages less than  $+V_S$  and  $-V_S$  respectively.

## POWER SUPPLY SEQUENCING

If separate boost supplies are not used, then connect  $+V_B$  to  $+V_S$  and  $-V_B$  to  $-V_S$ .

If separate boost supplies are used, then use the following sequence:

Turn ON Sequence:  $\pm V_S, \pm V_B$

Turn OFF Sequence:  $\pm V_B, \pm V_S$

To make sure  $\pm V_B$  are not less than 1 diode drop below  $\pm V_S$ , Apex recommends (small signal) diodes to be connected between  $+V_S$  (anode) and  $+V_B$  (cathode) and between  $-V_S$  (cathode) and  $-V_B$  (anode), as shown in Figure 2: Typical Connection (diodes D3 & D4).

Alternatively, replacing diodes D3 and D4 in Figure 2 with 15V, 1W Zener diodes allows for the use of power supply sequence  $\pm V_B, \pm V_S$  when switching on, and reversely  $\pm V_S, \pm V_B$ , when switching off. These Zener diodes will prevent voltage difference between  $V_B$  and  $V_S$  greater than  $|15V|$  under either power supply sequence. With  $\pm V_B$  turned on before  $\pm V_S$ , the voltage difference between the two power supply pins will not exceed approximately 15V. This is well within the limit. With the standard power supply sequence  $\pm V_S$  will still be clamped at 1 diode voltage drop below  $\pm V_B$ .

## TEMPERATURE SENSING

The case temperature of the PA164/PA165 can be monitored using the  $V_{TEMP}$  pin. The  $V_{TEMP}$  provides an output voltage that corresponds to the change in case temperature. The scale factor of the temperature sensor is 14.7mV/°C. At an ambient temperature of 25°C, the typical output voltage at the pin is 2V. The temperature error of the sensor is  $\pm 2.2^\circ\text{C}$ .

## **CURRENT LIMIT**

For proper operation, the current limit resistor ( $R_{CL}$ ) must be connected as shown in the external connection diagram. The  $R_{CL}$  resistor sets the precision current limit for the amplifier output. The resistor should be connected inside the feedback loop. The current limit level can be determined by the following equation:

$$R_{CL} = \frac{0.465 V}{I_{CL}}$$

## **SOA CONSIDERATIONS FOR PA165:**

The PA165 is a high power density operational amplifier with the capability of driving high current up to 4A continuous at high voltages. However, precautions must be taken when driving the amplifier to achieve higher currents of 3A and above.

When using the PA165 for currents higher than 3A, use boost supplies ( $|V_B| = |V_S| + 10V$ ) to reduce internal power dissipation in the output stage in order to operate the amplifier within the SOA. Since the typical voltage swing of the PA165 is  $+V_S - 8V$  for positive supply, and  $-V_S + 6V$  for negative supply, it is easy to exceed the maximum internal power dissipation specification of 32W when the output current is higher than 3A.

## **INTEGRATED OVER CURRENT FLAG**

The PA164/PA165 contains an over-current flag pin. Connect a 5 k $\Omega$  resistor between this pin and a 5V source referenced to ground, as shown in the typical connection drawing. The over current flag pin can be then used as a 0-5V logic. When the amplifier goes into current limit mode, the pin will sink 1mA current and 5V will be dropped across the resistor. In this configuration, 5V at the pin will indicate no current limit, while 0V at the pin indicates that the amplifier is set in current limit.

## **INTEGRATED SHUT DOWN FEATURE**

PA164/PA165 includes a shut-down circuit that allows turning off the output stage of the amplifier, preventing any input signal from passing through the amplifier. The amplifier will work in normal operating mode when the shutdown pin is grounded or left floating. The output is disabled when the shutdown pin is brought high, 5V.

## **POWER SUPPLY BYPASSING**

Bypass capacitors to power supply terminals  $+V_S$ ,  $-V_S$ ,  $+V_B$ , and  $-V_B$  must be connected physically close to the pins to prevent local parasitic oscillation in the output stage of the PA164/PA165. Use electrolytic capacitors at least 10 $\mu$ F per output amp required. Bypass the electrolytic capacitors with high quality ceramic capacitors (X7R) 0.1 $\mu$ F or greater.

---

## POWER SUPPLY PROTECTION

Unidirectional transient Voltage suppressors are recommended as protection on the supply pins. TVS diodes clamp transients to voltages within the power supply rating and clamp power supply reversals to ground. Whether the TVS diodes are used or not, the system power supply should be evaluated for transient performance including power-on overshoot and power-off polarity reversal as well as line regulation. Conditions which can cause open circuits or polarity reversals on either power supply rail should be avoided or protected against. Reversals or opens on the negative supply rail is known to induce input stage failure. Unidirectional TVS diodes prevent this, and it is desirable that they be both electrically and physically as close to the amplifier as possible.

**PACKAGE OPTIONS**

Part Number	Apex Package Style	Description
PA164	PQ	52-pin power quad
PA165	PQ	52-pin power quad

**PACKAGE STYLE PQ**

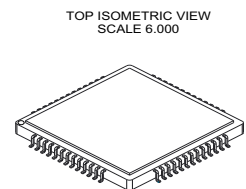
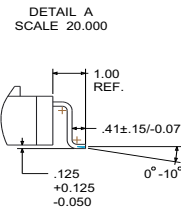
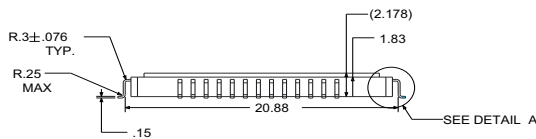
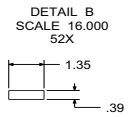
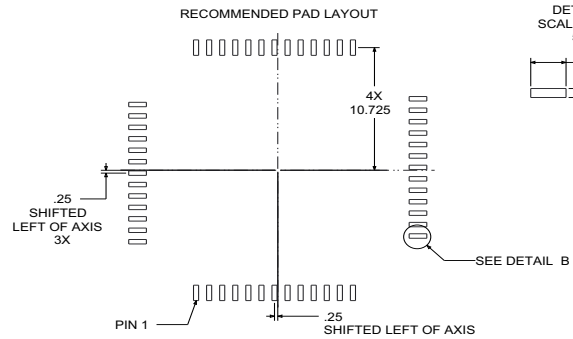
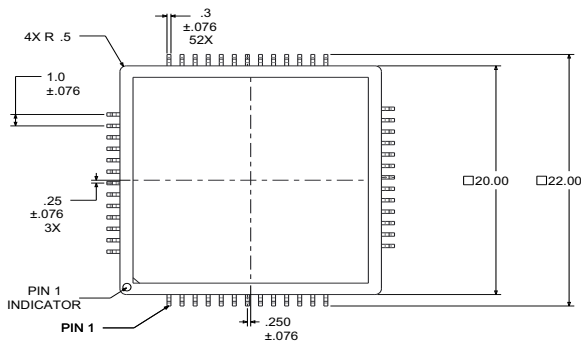

**NOTES:**

1. DIMENSIONS ARE IN MM [IN].
2. UNLESS OTHERWISE NOTED, TOLERANCES ARE ±.25 [.010].
3. ANGLE TOLERANCES ARE ±3°.
4. DRAWING SCALE IS 8.000.
5. ALL LEADS TO BE COPLANAR WITHIN 0.1 [.004].

---

## NEED TECHNICAL HELP? CONTACT APEX SUPPORT! 20

For all Apex Microtechnology product questions and inquiries, call toll free 800-546-2739 in North America. For inquiries via email, please contact [apex.support@apexanalog.com](mailto:apex.support@apexanalog.com). International customers can also request support by contacting their local Apex Microtechnology Sales Representative. To find the one nearest to you, go to [www.apexanalog.com](http://www.apexanalog.com)

### IMPORTANT NOTICE

Apex Microtechnology, Inc. has made every effort to insure the accuracy of the content contained in this document. However, the information is subject to change without notice and is provided "AS IS" without warranty of any kind (expressed or implied). Apex Microtechnology reserves the right to make changes without further notice to any specifications or products mentioned herein to improve reliability. This document is the property of Apex Microtechnology and by furnishing this information, Apex Microtechnology grants no license, expressed or implied under any patents, mask work rights, copyrights, trademarks, trade secrets or other intellectual property rights. Apex Microtechnology owns the copyrights associated with the information contained herein and gives consent for copies to be made of the information only for use within your organization with respect to Apex Microtechnology integrated circuits or other products of Apex Microtechnology. This consent does not extend to other copying such as copying for general distribution, advertising or promotional purposes, or for creating any work for resale.

APEX MICROTECHNOLOGY PRODUCTS ARE NOT DESIGNED, AUTHORIZED OR WARRANTED TO BE SUITABLE FOR USE IN PRODUCTS USED FOR LIFE SUPPORT, AUTOMOTIVE SAFETY, SECURITY DEVICES, OR OTHER CRITICAL APPLICATIONS. PRODUCTS IN SUCH APPLICATIONS ARE UNDERSTOOD TO BE FULLY AT THE CUSTOMER OR THE CUSTOMER'S RISK.

Apex Microtechnology, Apex and Apex Precision Power are trademarks of Apex Microtechnology, Inc. All other corporate names noted herein may be trademarks of their respective holders.