

CMMI Series For HDMI, USB 3.0

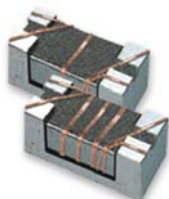

A full series of common mode choke is designed for excellent noise attenuation and compact sizing for use in wide range of applications. Both standard series and custom designs are available.

Features

- RoHS Compliant
- Miniature SMD type common mode filter for fully automated assembly
- Excellent solderability

Applications

- HDMI
- USB lines (for personal computers and peripheral), DVC, STB, LVDS, panel line for liquid display panels, etc.

Product Identification

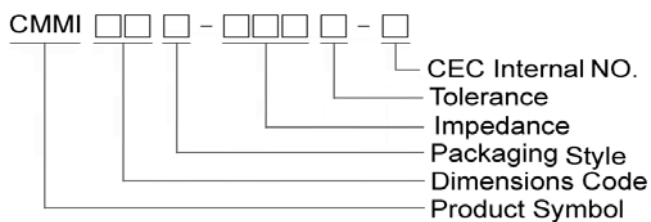

- Packaging: T : Tape and Reel

Shape and Dimensions

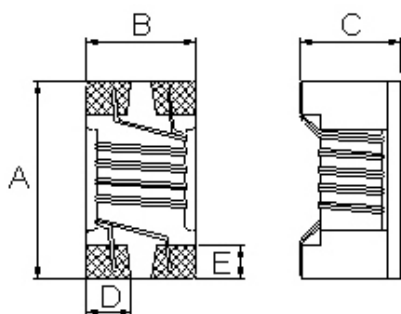

Dimensions in mm

TYPE	A	B	C	D	E
CMMI11	1.25±0.2	1.00±0.2	0.80±0.1	0.32	0.33
CMMI21	2.05±0.2	1.25±0.2	1.20±0.2	0.50	0.58

Recommended Pattern

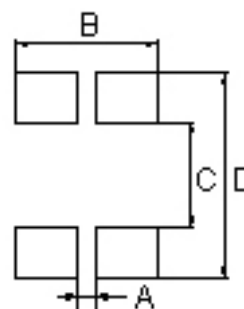

Dimensions in mm

TYPE	A	B	C	D
CMMI11	0.36	1.00	0.59	1.75
CMMI21	0.50	1.20	0.80	2.60

Electrical Characteristics

Part Number	Impedance (Ω)	Test Frequency (MHz)	Tolerance (±%)	Idc (mA) Max	Rated Voltage (Vdc)	Rdc (Ω) Max	Insulation Resistance (MΩ) Min
CMMI11T-600Y-N	60	100	25	250	20	0.40	10
CMMI11T-900Y-N	90	100	25	250	20	0.30	10

- When ordering, please specify tolerance and packaging codes
- Tolerance : Y = ±25%
- Packaging : Clear tape and reel { standard }
- Z : HP4286A / HP4287A / Agilent E4991A + Agilent16197A
- Rdc(single line) :CH502BC
- Idc : HP4284A+HP42841A/HP4285A+HP42841A
- Insulation Resistance : Agilent HP4339B
- Operating temperature range from -40°C to 105°C . (Including self - temperature rise)

Test Instruments : HP4291A Material/Impedance Analyzer

Typical Impedance vs. Frequency

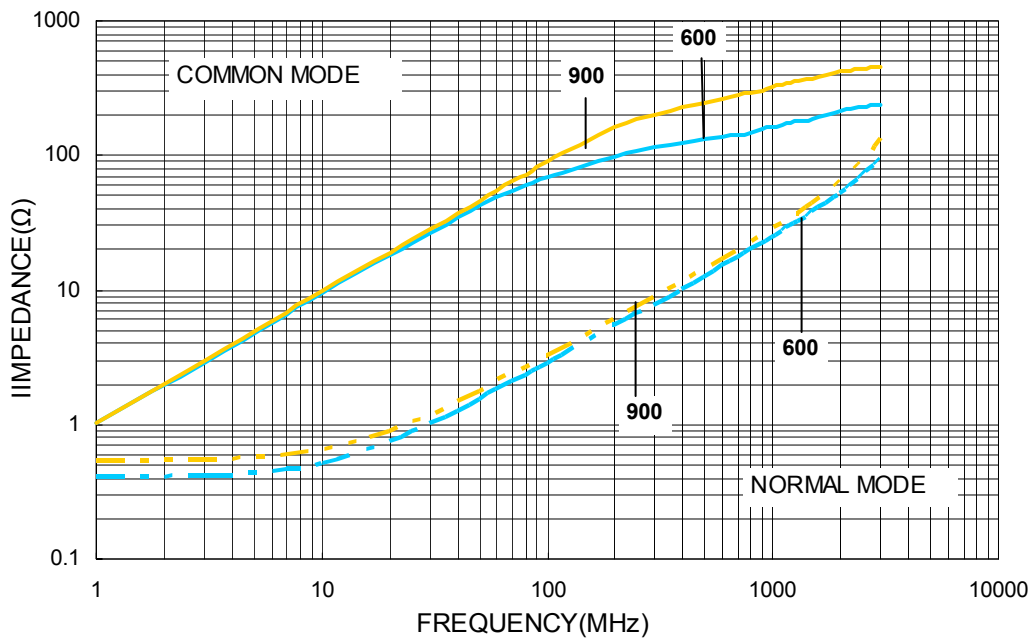

CMMI11T-600Y-N

Insertion Loss For HDMI Testing:

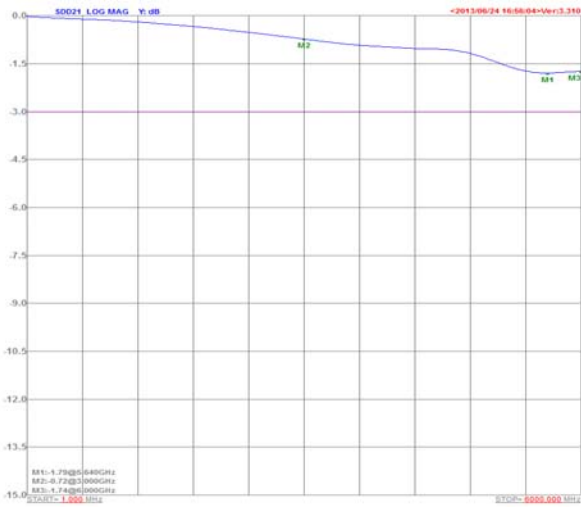

Insertion Loss For USB3.0 Testing:

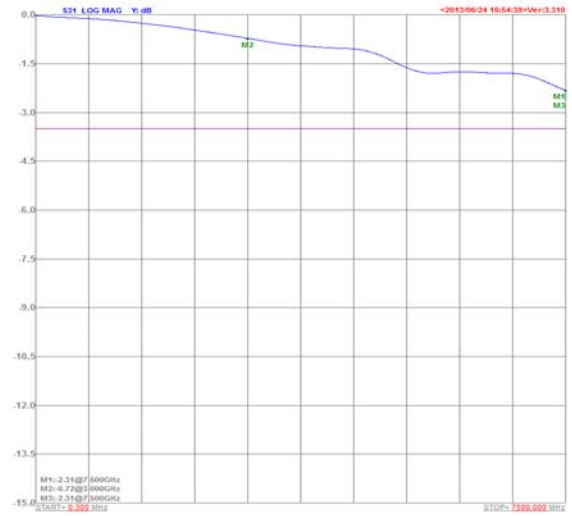

TDR For HDMI Testing:

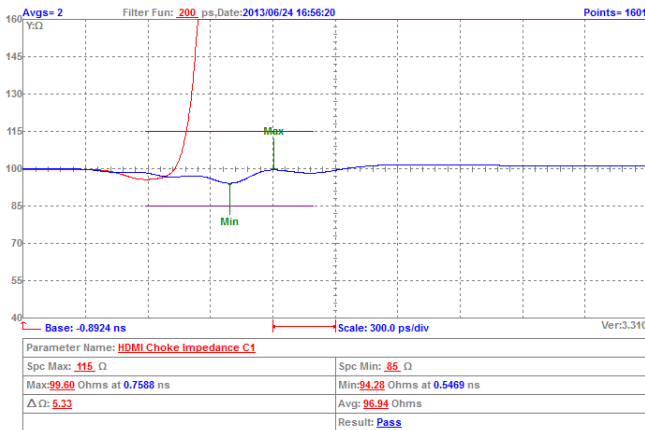

TDR For USB3.0 Testing:

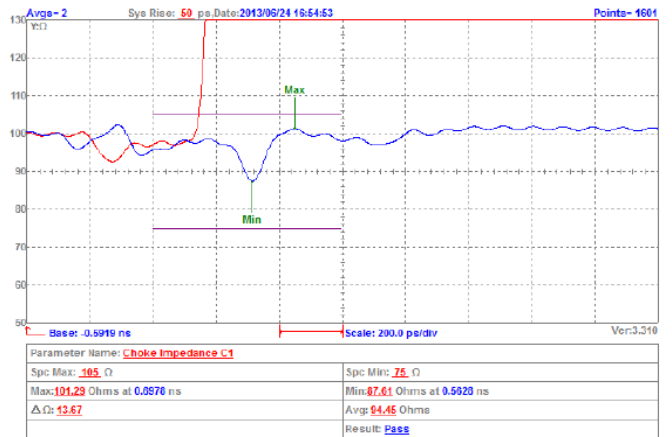

Eye Diagram For HDMI Testing:

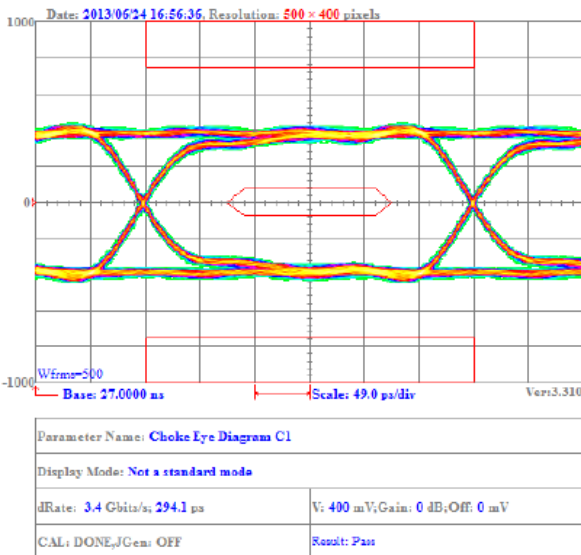

Eye Diagram For USB3.0 Testing:

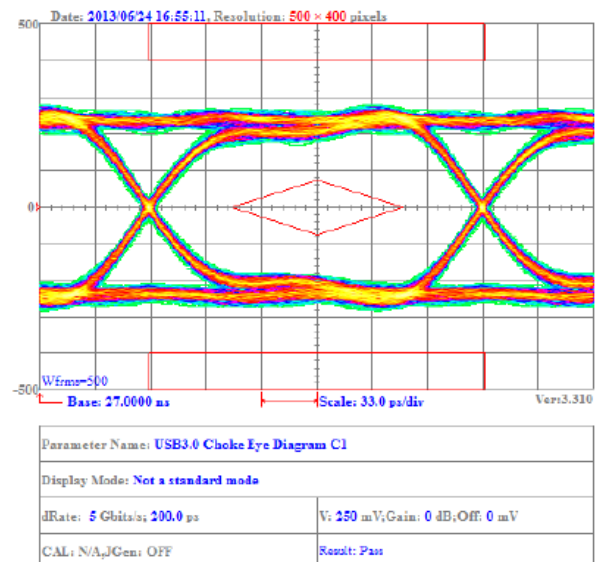

CMMI11T-900Y-N

Insertion Loss For HDMI Testing:

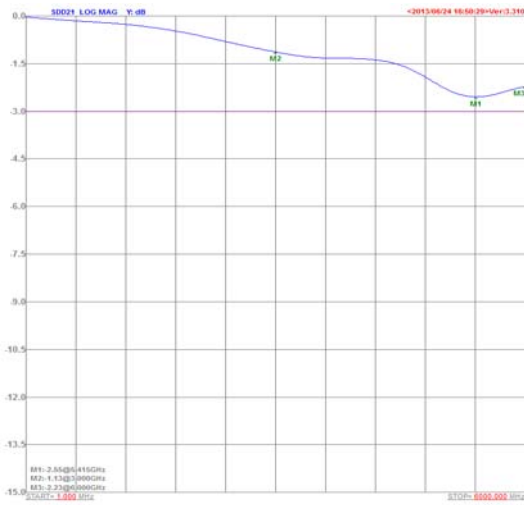

Insertion Loss For USB3.0 Testing:

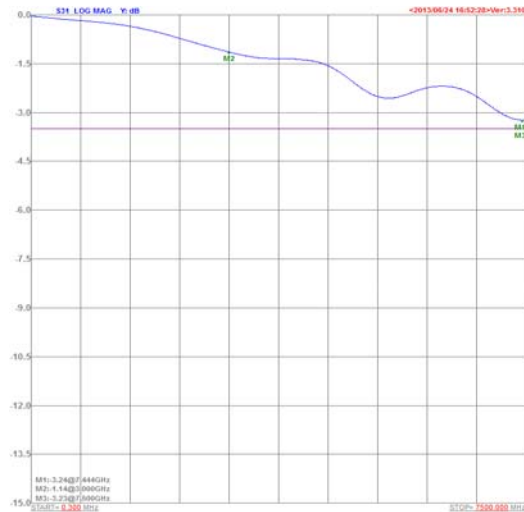

TDR For HDMI Testing:

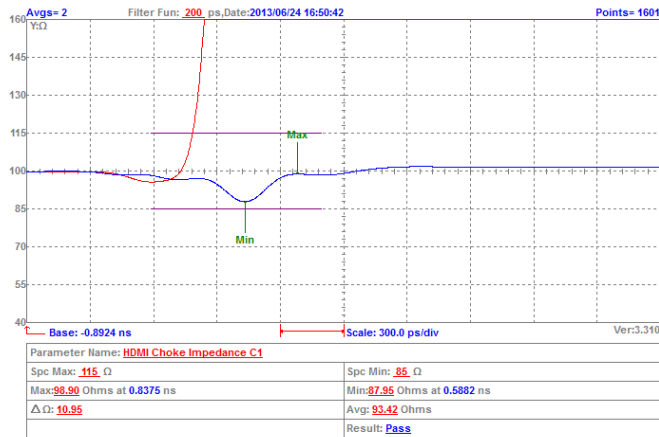

TDR For USB3.0 Testing:

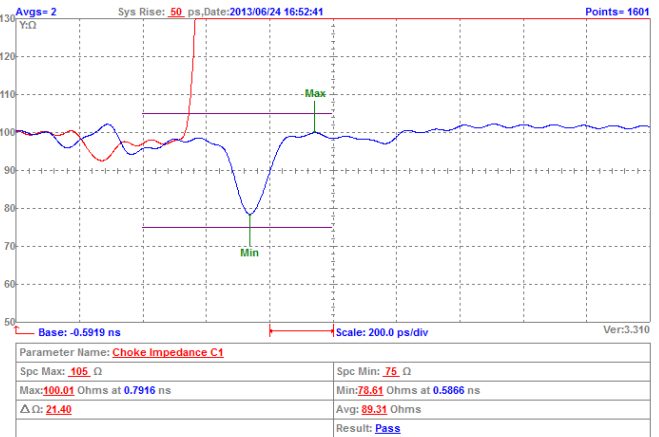

Eye Diagram For HDMI Testing:

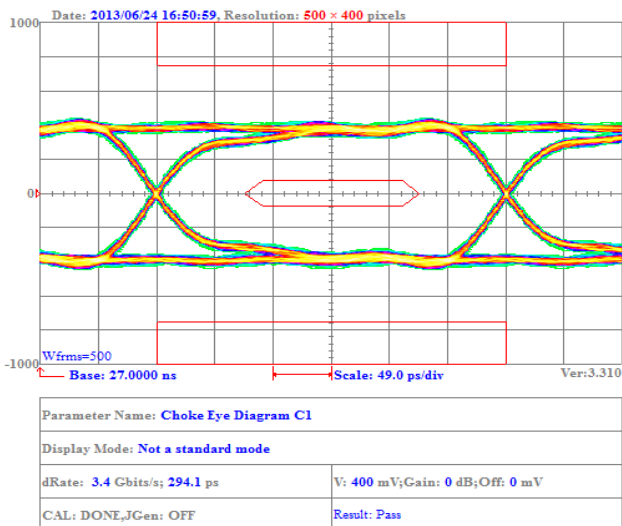

Eye Diagram For USB3.0 Testing:

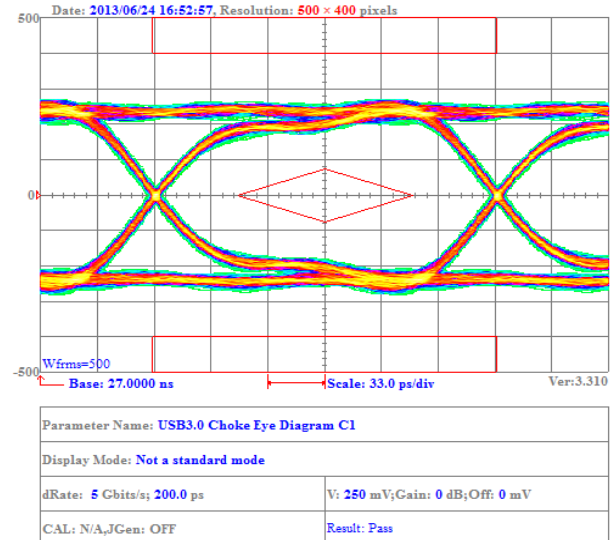

Electrical Characteristics

Part Number	Impedance (Ω)	Test Frequency (MHz)	Tolerance (±%)	Idc (mA) Max	Rated Voltage (Vdc)	Rdc (Ω) Max	Insulation Resistance (MΩ) Min
CMMI21T-500Y-N	50	100	25	500	50	0.20	10
CMMI21T-670Y-N	67	100	25	500	50	0.30	10
CMMI21T-900Y-N	90	100	25	330	50	0.30	10
CMMI21T-121Y-N	120	100	25	330	50	0.35	10
CMMI21T-131Y-N	130	100	25	300	50	0.40	10

- When ordering, please specify tolerance and packaging codes
- Tolerance : Y = ±25%
- Packaging : Clear tape and reel { standard }
- Z : HP4286A / HP4287A / Agilent E4991A + Agilent16197A
- Rdc(single line) :CH502BC
- Idc : HP4284A+HP42841A/HP4285A+HP42841A
- Insulation Resistance : Agilent HP4339B
- Operating temperature range from -40°C to 105°C . (Including self - temperature rise)

Test Instruments : HP4291A Material/Impedance Analyzer

Typical Impedance vs. Frequency

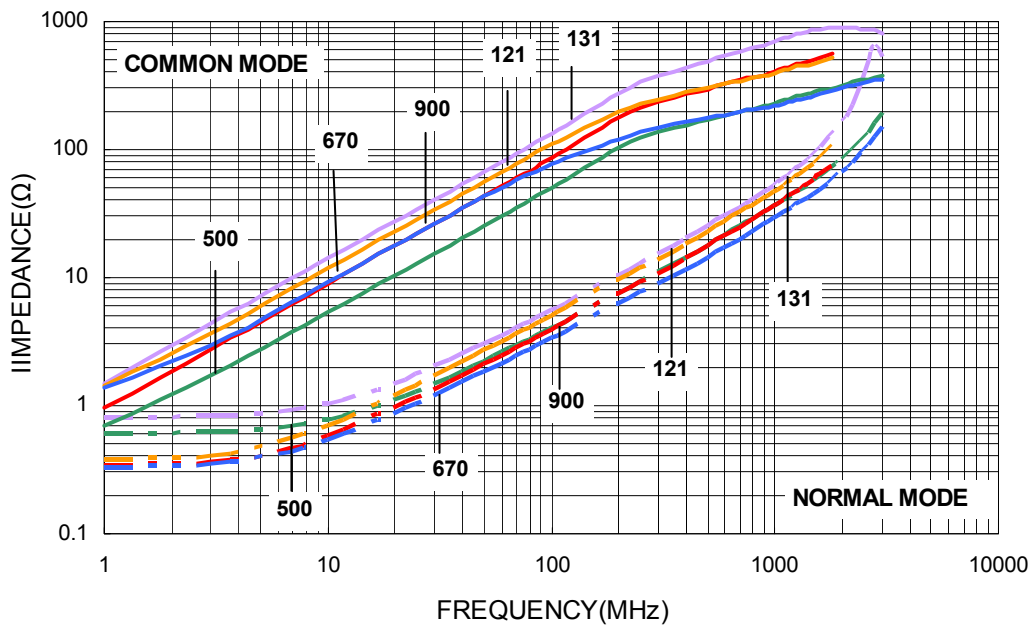

CMMI21T-500Y-N

Insertion Loss For HDMI Testing:

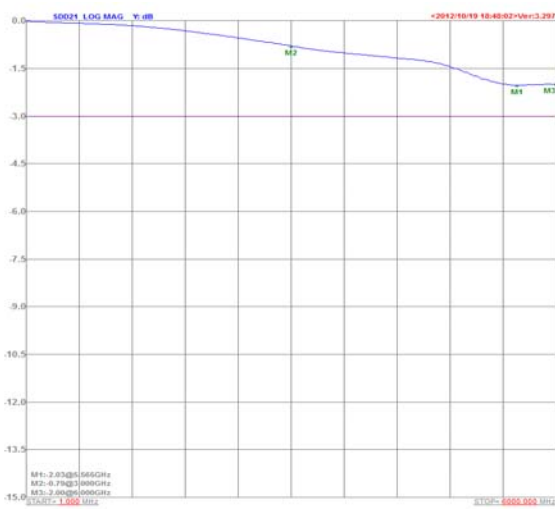

Insertion Loss For USB3.0 Testing:

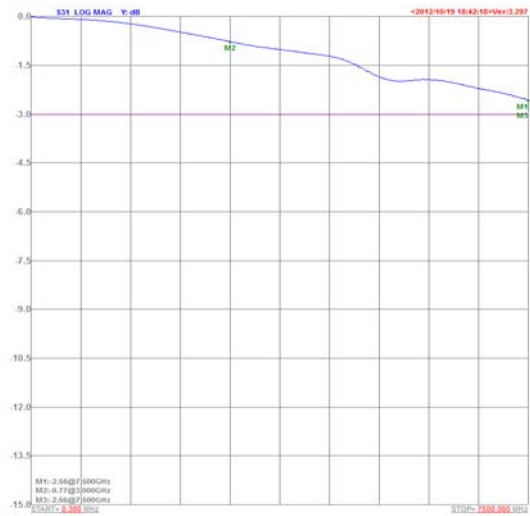

TDR For HDMI Testing:

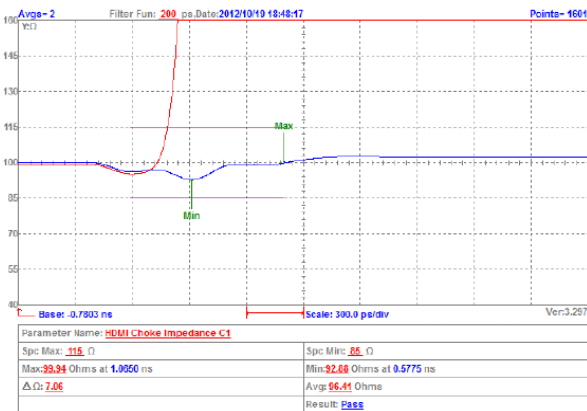

TDR For USB3.0 Testing:

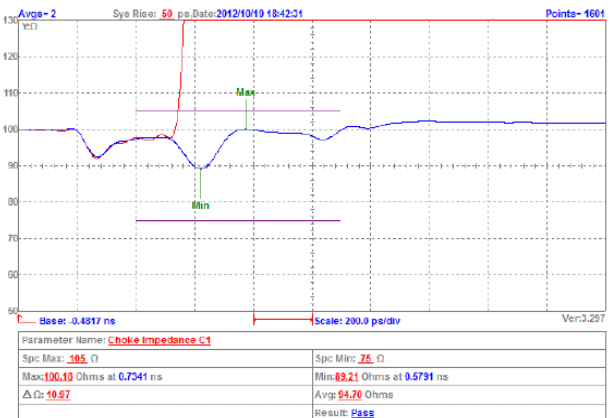

Eye Diagram For HDMI Testing:

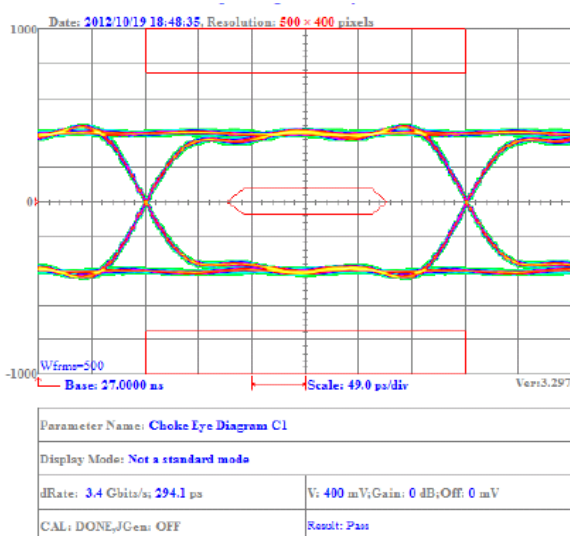

Eye Diagram For USB3.0 Testing:

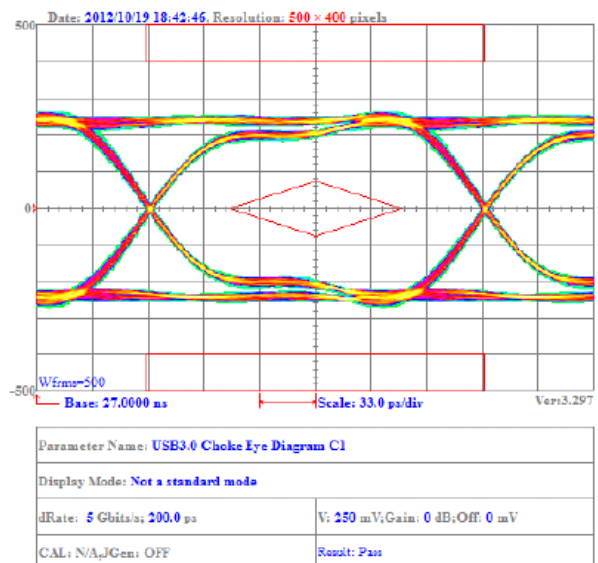

CMMI21T-670Y-N

Insertion Loss For HDMI Testing:

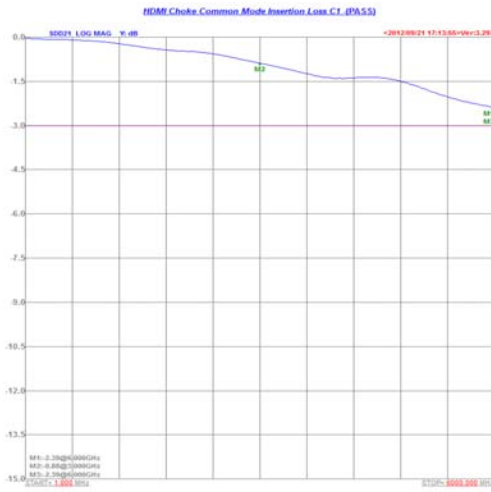

Insertion Loss For USB3.0 Testing:

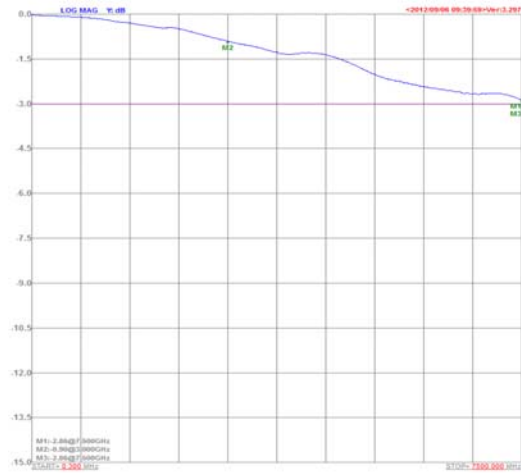

TDR For HDMI Testing:

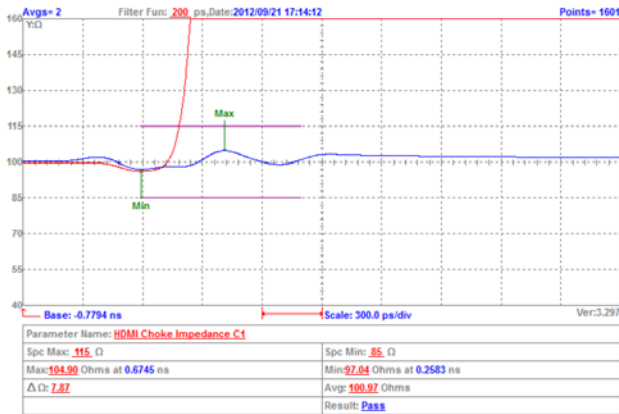

TDR For USB3.0 Testing:

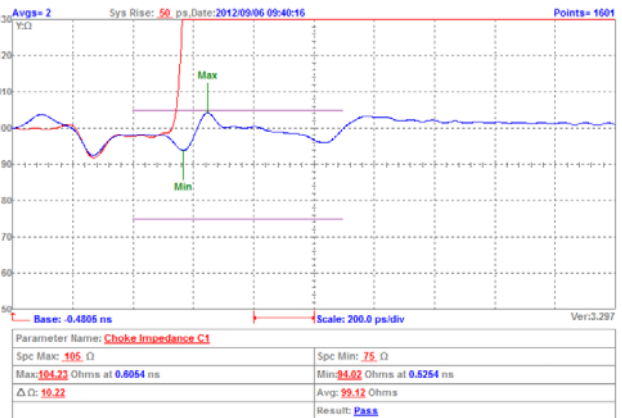

Eye Diagram For HDMI Testing:

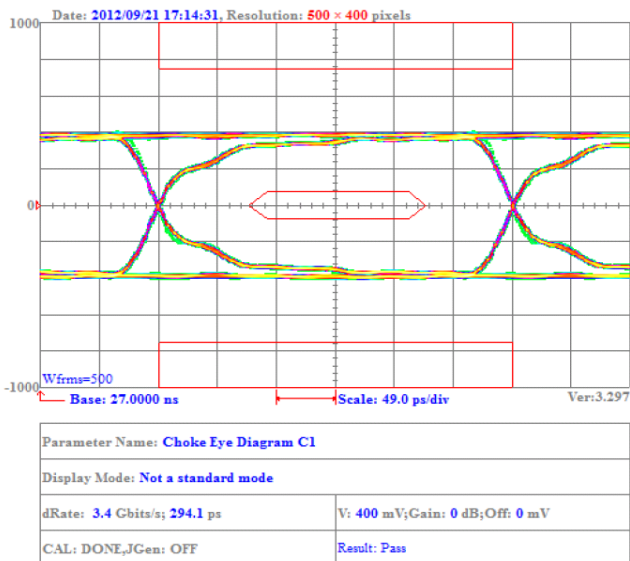

Eye Diagram For USB3.0 Testing:

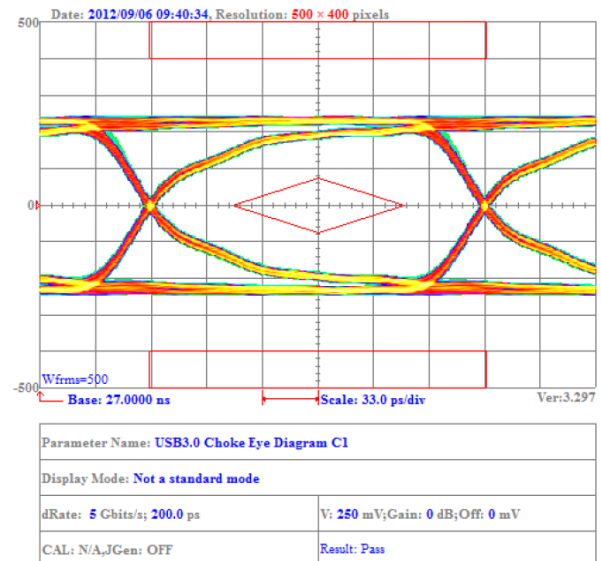

CMMI21T-900Y-N

Insertion Loss For HDMI Testing:

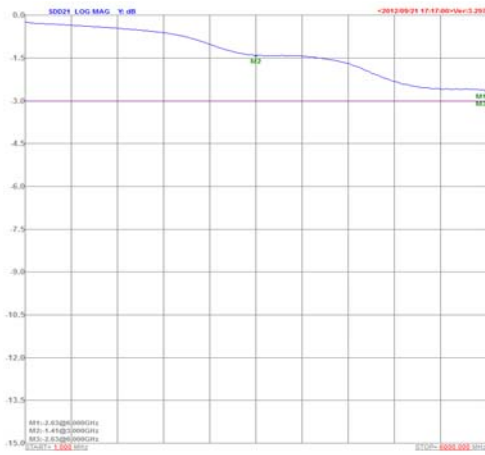

Insertion Loss For USB3.0 Testing:

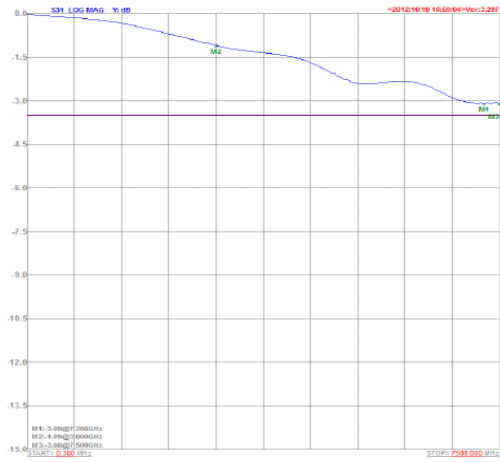

TDR For HDMI Testing:

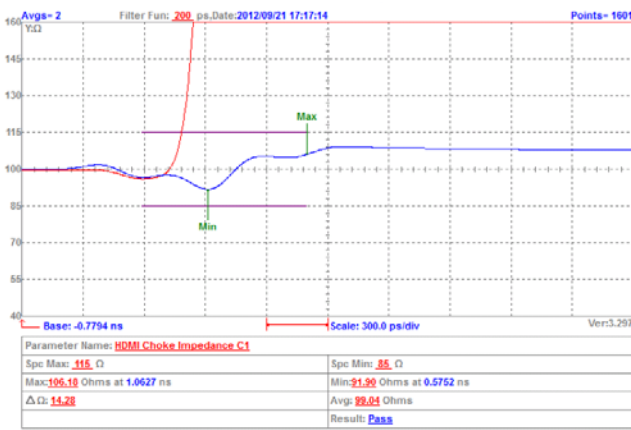

TDR For USB3.0 Testing:

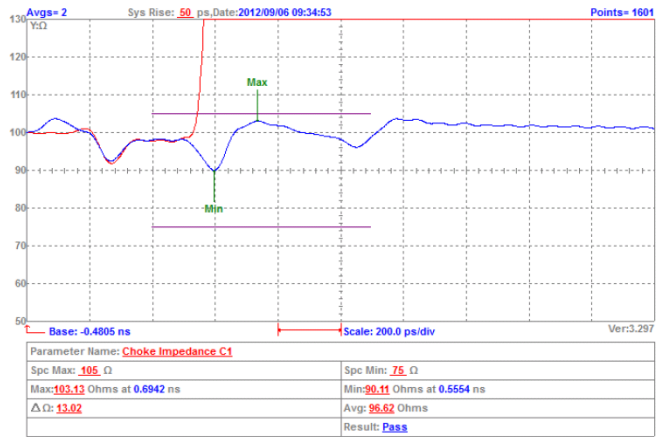

Eye Diagram For HDMI Testing:

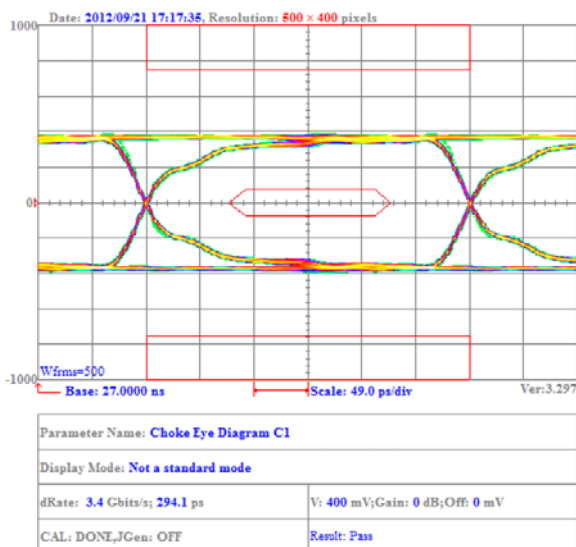

Eye Diagram For USB3.0 Testing:

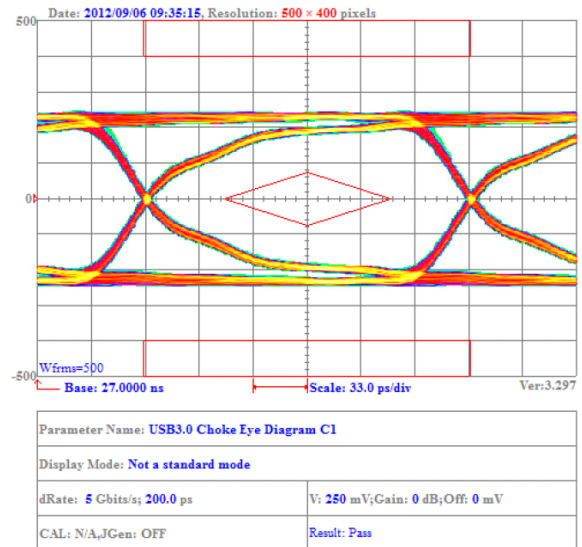

CMMI21T-121Y-N

Insertion Loss For HDMI Testing:

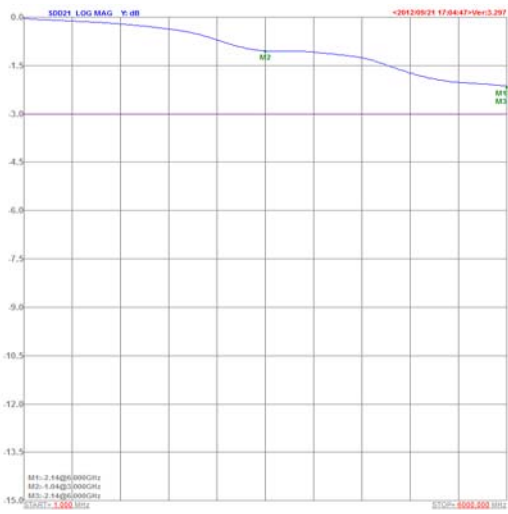

Insertion Loss For USB3.0 Testing:

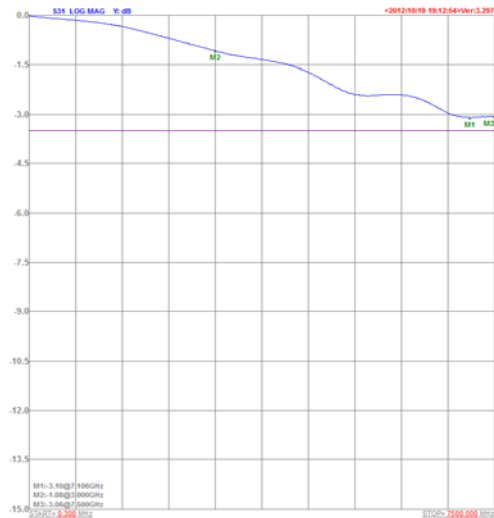

TDR For HDMI Testing:

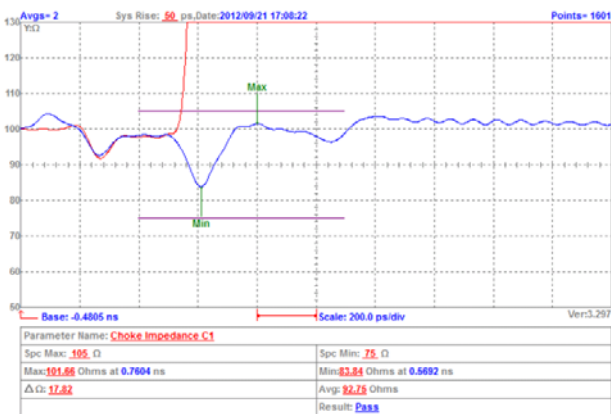

TDR For USB3.0 Testing:

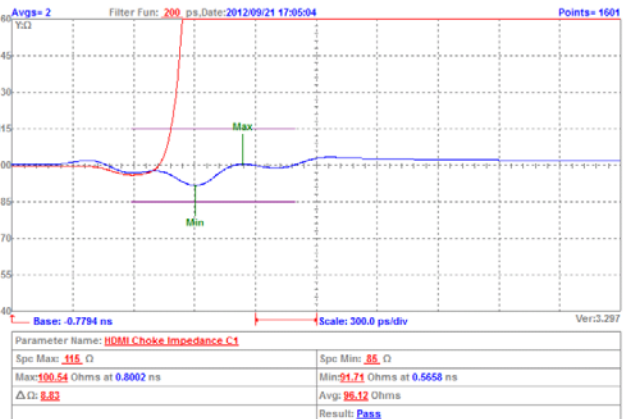

Eye Diagram For HDMI Testing:

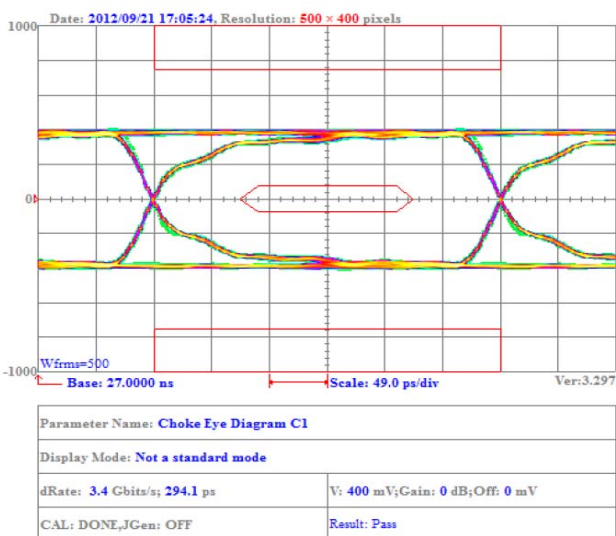

Eye Diagram For USB3.0 Testing:

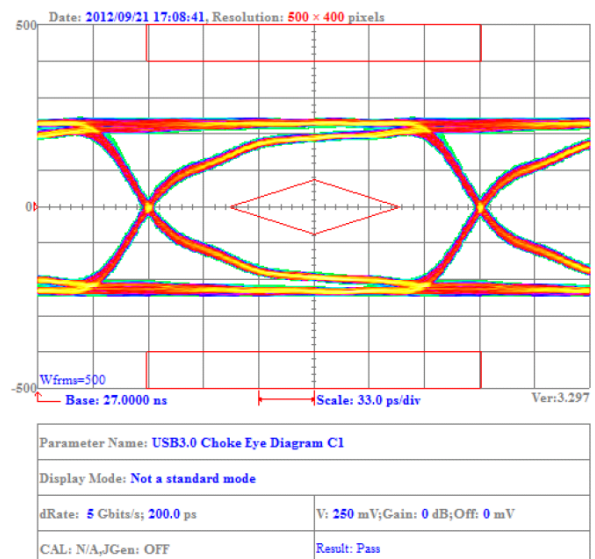

CMMI21T-131Y-N

Insertion Loss For HDMI Testing:

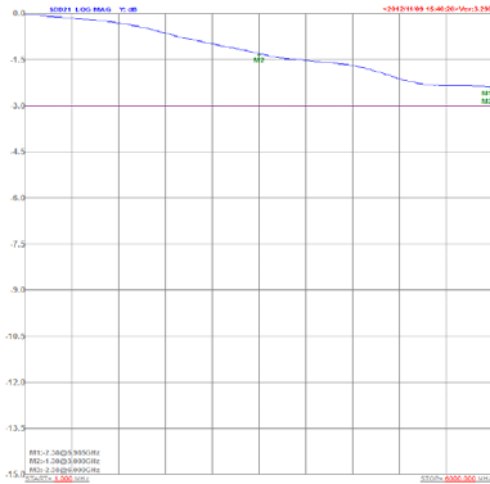

Insertion Loss For USB3.0 Testing:

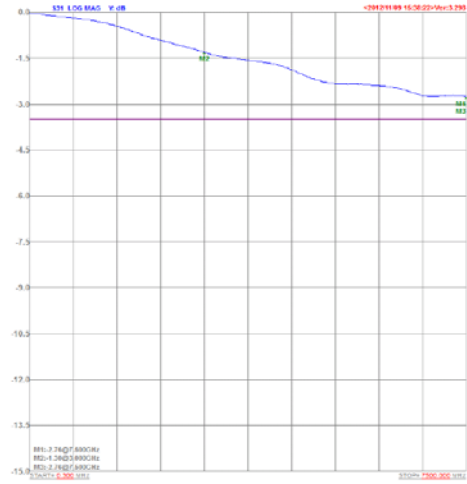

TDR For HDMI Testing:

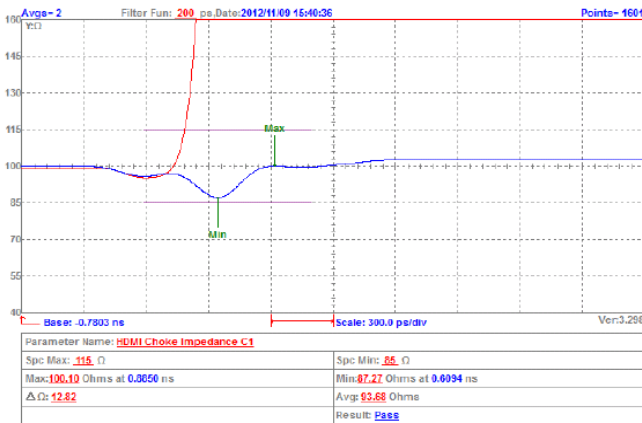

TDR For USB3.0 Testing:

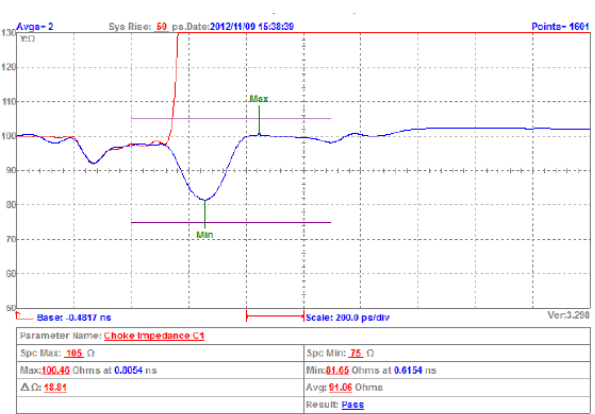

Eye Diagram For HDMI Testing:

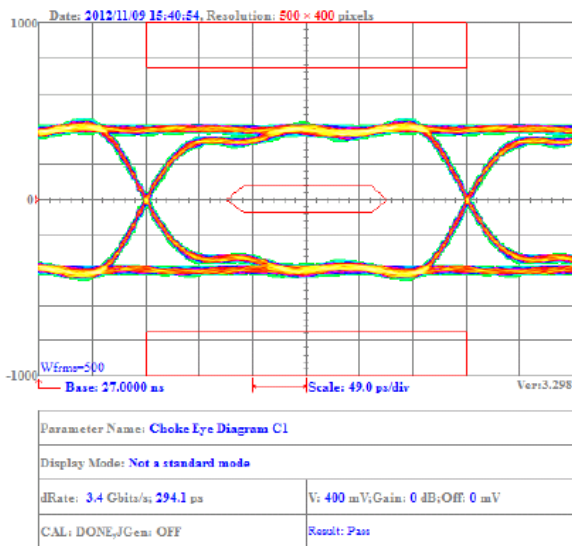

Eye Diagram For USB3.0 Testing:

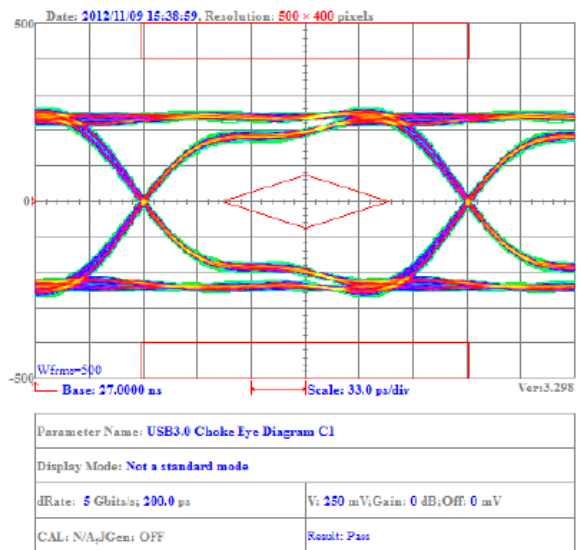

Packaging Specifications

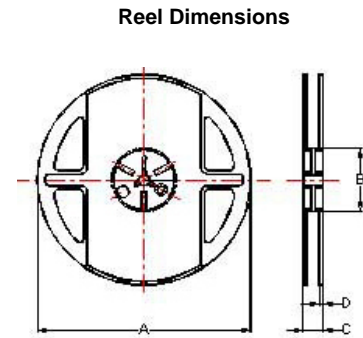
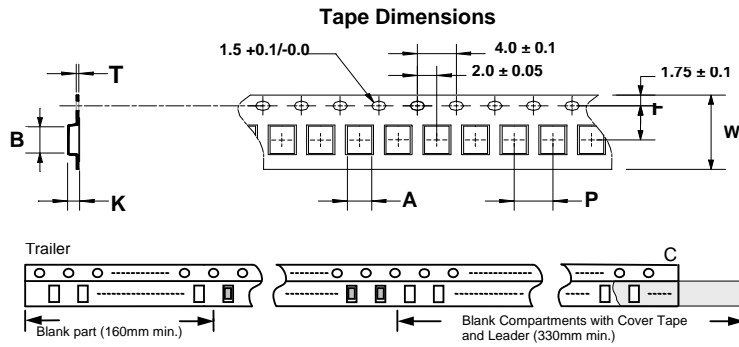

Dimensions in mm

TYPE	Tape Dimensions							Reel Dimensions				Quantity PCS / Reel
	A	B	T	W	P	F	K	A	B	C	D	
CMMI11	1.10	1.40	0.25	8	4	3.5	1.00	178	60	12	1.5	2000
CMMI21	1.50	2.25	0.24	8	4	3.5	1.35	178	60	12	1.5	2000